



GEC 5.0-9.6kW G1(US) Split Phase User Manual



Ver.1.1

AC-Coupled Inverter

www.gesolarinverter.com

TABLE OF CONTENTS

01 Introduction	1
1.1 Operation Modes Introduction	1
1.2 Safety and Warning	2
1.3 Product Overview	6
1.4 User Interface Introduction	7
02 Installation Instructions	8
2.1 Unacceptable Installations	8
2.2 Packing List	9
2.3 Mounting	9
2.3.1 Select Mounting Location	9
2.3.2 Wall Mounted Bracket And Inverter Installation.....	10
2.4 Conduit and Wiring Installation.....	13
2.4.1 Wiring Box Conduit Plugs.....	14
2.4.2 Battery Wiring Connection.....	14
2.4.3 On-Grid / AC Connection.....	16
2.4.4 Back-up Connection	18
2.4.5 Auto-transformer Connection (Optional).....	22
2.4.6 CT Connections.....	25
2.4.7 Battery BMS Connection	26
2.4.8 WiFi Communication Connection	27
2.5 Storage Mate App.....	27
2.6 Wiring System For GEC Series Inverter (Full Backup)	28
2.7 Wiring System For GEC Series Inverter(Partial Backup)	30

03 OTHER..... 32

- 3.2 Troubleshooting.....34
- 3.3 Disclaimer.....37
- 3.4 Technical Parameters38
 - 3.4.1 Inverter Specification..... 38
 - 3.4.2 Auto-transformer Specification..... 43
 - 3.4.3 Grid Parameter Setting 44
 - 3.4.3 Grid Parameter Setting 44
- 3.5 Maintenance.....45
 - 3.5.1 Clearing and Replacing Fans..... 45
 - 3.5.2 Fuse Replacement 46
 - 3.5.3 About Periodical Maintenance..... 47

Appendix 48

01 Introduction

The GEC series, also called AC-coupled or bidirectional inverters, provides energy management in a PV system that includes solar modules (or not), a battery, loads, and utility grid connection.

Energy produced by the PV system will be used to optimize self-consumption, excess will be used to charge the battery, anymore could be exported to the grid. The battery shall discharge to support loads when PV power is insufficient to meet self-consumption needs. If battery power is not sufficient, the system will take power from the utility grid to support loads.

When the GEC inverter is operating in off-grid mode (disconnected the utility grid), it will create a micro-grid. The PV Inverter will accept this micro-grid and will therefore operate even during a blackout. Similar to on-grid mode: when the PV power exceeds the load, excess will be charged the battery through the GEC inverter.

1.1 Operation Modes Introduction

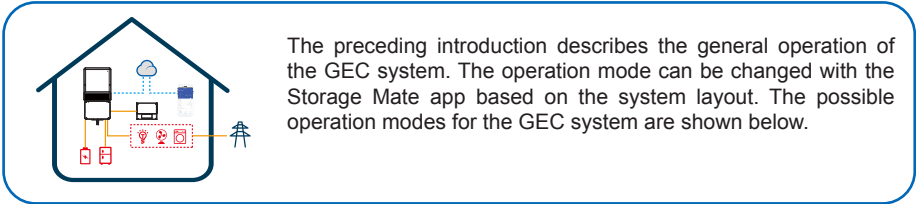

GEC system normally has the following operation modes based on your configuration and layout conditions.

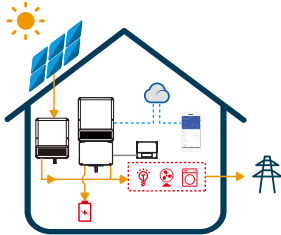

Mode I

Energy from PV inverter optimize loads, excess will be used to charge the battery, any remaining excess will be exported to the grid.

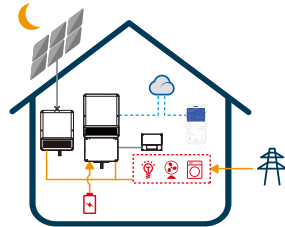

Mode II

When energy from PV inverter is weak, battery will discharge to support the load in priority together with the grid.

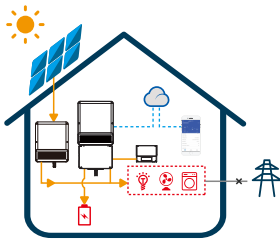

Mode III

When grid power fails, GEC inverter creates a micro grid, and the weight of the load determines whether PV energy flows into the load or charges the battery.

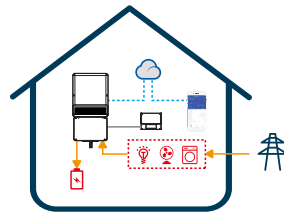

Mode IV

Battery could be charged by grid, and charge time/power could be set flexibly on Storage Mate APP.

1.2 Safety and Warning

GEC series AC-COUPLED inverter has been designed and tested in accordance with safety requirements. As with power electronic devices, there are residual risks despite strict standards. You are recommended to read the following information carefully to prevent personal injury and property damage.

SAVE THESE INSTRUCTIONS - This manual contains important instructions for GEC AC-COUPLED INVERTER that shall be followed during installation and maintenance of the inverter.



These servicing instructions are for use by qualified personnel only. To reduce the risk of electric shock, do not perform any servicing other than that specified in the operating instructions.

Ces instructions d'entretien sont destinées uniquement au personnel qualifié. Pour réduire le risque de choc électrique, n'effectuez aucun service autre que celui spécifié dans les instructions d'exploitation.

Symbol Explanation



DANGER indicates a hazardous situation which, if not avoided, will result in death or serious injury.

DANGER indique une situation dangereuse qui, si elle n'est pas évitée, est susceptible de provoquer un décès ou des blessures graves.



WARNING indicates a hazardous situation which, if not avoided, could result in death or serious injury.

AVERTISSEMENT indique une situation dangereuse qui, si elle n'est pas évitée, est susceptible de provoquer un décès ou des blessures graves.



CAUTION indicates a hazardous situation which, if not avoided, could result in minor or moderate injury.

PRUDENCE indique une situation dangereuse qui, si elle n'est pas évitée, est susceptible de provoquer des blessures légères ou de degré moyen.



Danger of high voltage and electric shock!
Danger de haute tension et de choc électrique !



Hot Surface- To reduce the risk of burns-Do not touch.
Surface chaude- Pour réduire le risque de brûlures- Ne touchez pas



Components of the product can be recycled.
Les composants du produit peuvent être recyclés.



This side up! The package must always be transported, handled and stored in such a way as the arrows always point upwards.

Ce côté vers le haut! Le paquet doit toujours être transporté, manipulé et stocké de manière à ce que les flèches pointent toujours vers le haut.



No more than six (6) identical packages being stacked on each other.
Pas plus de six (6) paquets identiques étant empilés les uns sur les autres.



Products should not be disposed as household waste.
Les produits ne doivent pas être éliminés comme déchets ménagers.



Fragile - The package/product should be handled carefully and never be tipped over or slung.

Fragile - L'emballage/produit doit être manipulé avec soin et ne jamais être renversé ou en bandoulière.



Refer to the operating instructions.

Consultez les instructions d'exploitation.



Keep dry! The package/product must be protected from excessive humidity and must be stored under cover.

Restez au sec ! L'emballage/produit doit être protégé contre une humidité excessive et doit être stocké à couvert.



This symbol indicates that you should wait at least 5mins after disconnecting the inverter from the utility grid and from the PV panel before touching any inner live parts.

Ce symbole indique que vous devriez attendre au moins 5 minutes après avoir déconnecté l'onduleur de la grille d'utilité et du panneau PV avant de toucher les parties vivantes intérieures.



CSA certified

Certifié CSA

Safety Warnings

- Any installation and operation on inverter must be performed by qualified electricians, in compliance with standards, wiring rules or requirements of local authorities or grid company
- Toute installation et fonctionnement sur onduleur doivent être effectués par des électriciens qualifiés, conformément aux normes, aux règles de câblage ou aux exigences des autorités locales ou de la société de réseau.
- The input and output circuits are isolated from the enclosure and that system grounding, if required by Sections 690.41, 690.42 and 690.43 of the National Electric Code, ANSI/NFPA 70, is the responsibility of the installer.
- Les circuits d'entrée et de sortie sont isolés de l'enceinte et cette mise à la terre du système, si nécessaire par les sections 690.41, 690.42 et 690.43 du Code national de l'électricité, ANSI/NFPA 70, est la responsabilité de l'installateur.
- Any operation on AC or DC terminals when inverter is operational is prohibited.
- Toute opération sur le terminal AC ou DC lorsque l'onduleur est en service est interdite.
- Before any wiring connection or electrical operation on inverter, all DC and AC power must be disconnected from inverter for at least 5 minutes to make sure inverter is totally isolated to avoid electric shock.
- Avant toute connexion de câblage ou de fonctionnement électrique sur onduleur, toute la puissance DC et AC doit être déconnectée de l'onduleur pendant au moins 5 minutes pour s'assurer que l'onduleur est totalement isolé pour éviter les chocs électriques.
- The temperature of inverter surface might exceed 60°C during operation, so please make sure it has cooled down before touching it, and make sure the inverter is out of reach of children.
- La température de la surface de l'onduleur peut dépasser 60 °C pendant l'opération, alors assurez-vous qu'elle s'est refroidie avant de la toucher, et assurez-vous que l'onduleur est hors de portée des enfants.

- Do not open the inverter's cover or change any components without manufacturer's authorization, otherwise the warranty commitment for the inverter will be invalid.
- N'ouvrez pas la couverture de l'onduleur ou ne modifiez aucun composant sans l'autorisation du fabricant, sinon l'engagement de garantie pour l'onduleur sera invalide.
- Usage and operation of the inverter must follow instructions in this user manual, otherwise the protection design might be impaired and warranty commitment for the inverter will be invalid.
- L'utilisation et le fonctionnement de l'onduleur doivent suivre les instructions contenues dans ce manuel d'utilisation, sinon la conception de protection pourrait être imparée et l'engagement de garantie pour l'onduleur sera invalide.
- Appropriate methods must be adopted to protect inverter from electrostatic damage. Any damage caused by static is not warranted by manufacturer.
- Des méthodes appropriées doivent être adoptées pour protéger l'onduleur contre les dommages électrostatiques. Tout dommage causé par statique n'est pas justifié par le fabricant.
- Battery negative (BAT-) on inverter side is not grounded as default design. Connecting BAT- to EARTH IS strictly forbidden.
- Batterie négative (BAT-) sur le côté onduleur n'est pas fondée comme conception par défaut. Connecter BAT- à EARTH est strictement interdit.
- The inverter has built-in RCMU and may produce DC residual current of no more than 6mA. An external Type A RCD (with operating current $\geq 30\text{mA}$) can be used if required.
- L'onduleur a intégré RCMU et peut produire DC courant résiduel d'au plus 6mA. Un RCD externe de type A (avec courant d'exploitation de 30mA) peut être utilisé si nécessaire.
- Before connecting the GEC series inverter to the AC distribution grid, approval must be received by the appropriate local utility as required by national and state interconnection regulations.
- Avant de connecter l'onduleur de la série GEC au réseau de distribution AC, l'approbation doit être reçue par l'utilité locale appropriée comme l'exigent les règlements nationaux et d'interconnexion de l'État.
- All electrical installations must be carried out in accordance with the local electrical standards and the National Electrical Code ANSI/NFPA 70 or the Canadian Electrical Code CSA C22.1. Before connecting the inverter to the grid, contact your local grid operator. The electrical connection of the inverter must be carried out by qualified personnel only.
- Toutes les installations électriques doivent être effectuées conformément aux normes électriques locales et au Code national de l'électricité ANSI/NFPA 70 ou au Code canadien de l'électricité CSA C22.1. Avant de raccorder l'inverter au réseau, communiquez avec votre opérateur de réseau local. La connexion électrique de l'inverter ne doit être effectuée que par des personnes de quelifief.
- Do not touch non-insulated conductors.
- Ne touchez pas les conducteurs non isolés.
- Do not touch the DC conductors.
- Ne touchez pas les conducteurs de DC.
- Do not touch any live components of the inverters.
- Ne touchez pas à des composants vivants des onduleurs.
- Any equipment damage caused by incorrect cable connections is not covered by the warranty.
- Tout dommage causé par des connexions incorrectes au câble n'est pas couvert par la garantie.

- Operation personnel must wear proper PPE all the time when connecting cables.
- Le personnel d'exploitation doit porter l'EPI approprié tout le temps lors de la connexion des câbles.
- Incorrect installation of conduit may cause a water-proofing problem.
- L'installation non décorative du conducteur métallique peut causer un problème imperméable à l'eau.
- Class 1 wiring methods are to be used for field wiring connections to terminals of a Class 2 circuit.
- Les méthodes de câblage de classe 1 doivent être utilisées pour les connexions de câblage sur le terrain aux terminaux d'un circuit de classe 2.
- AC output (neutral) is not bonded to ground.
- La sortie d'AC (neutre) n'est pas collée au sol.
- To reduce the risk of fire, please add an overcurrent protection device (OCPD or 'circuit breaker') in accordance with the National Electrical Code ANSI / NFPA 70.
- Pour réduire le risque d'incendie, veuillez ajouter un disjoncteur de protection trop courant conformément au Code National d'Électricité ANSI / NFPA 70.

1.3 Product Overview

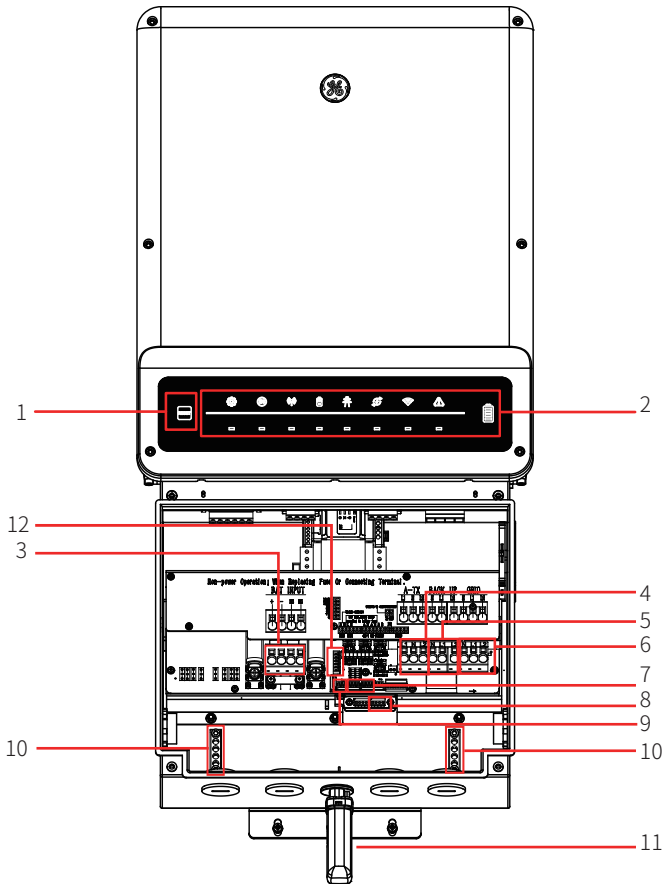

- | | | |
|--|---------------------------------|---|
| 1. WiFi Reset | 2. LCD | 3. BAT Input Terminal
- BAT INPUT |
| 4. Auto-transformer Terminal
- A-TX | 5. Backup Terminal
- BACK UP | 6. On Grid Terminal
- GRID |
| 7. BMS ^[1] | 8. Meter CT Terminal | 9. EMS ^[2] |
| 10. PE Terminal | 11. WiFi Module | 12. LG Enable & 12V Power &
Dry Contact ^[3] |

[1] BMS: For battery communication with the inverter.

[2] EMS: Used to upgrade programs and communicate with third-party monitoring software.

[3] Dry Contact: DRY+&DRY-, used to start or stop the generator by connecting the inverter to DRY INPUT of the generator.

1.4 User Interface Introduction

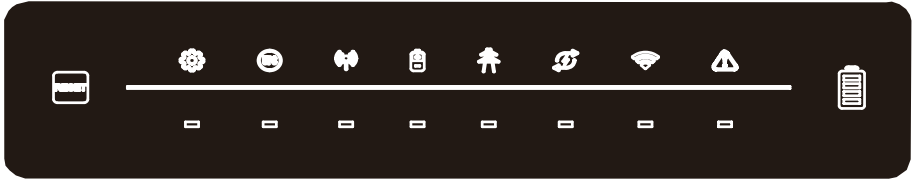

Wi-Fi reset & reload

Wi-Fi reset means restarting Wi-Fi module. Wi-Fi settings will be reprocessed and saved automatically. Wi-Fi Reload means setting Wi-Fi module back to default factory setting.

Wi-Fi reset

Short press reset button.
Wi-Fi LED will blink for a few seconds.

Wi-Fi reload

Long press reset button (longer than 3s).
The Wi-Fi LED will double blink until the WiFi configuration is reloaded.

Note:

WiFi reset and reload functions are only used when:

1. WiFi loses connection to internet or cannot connect to Storage Mate App successfully.
2. Cannot find "Solar-WiFi signal" or have other WiFi configuration problems.
3. Please do not use this button if WiFi monitoring works well.

LED Indicators

INDICATOR	COLOR	STATUS	EXPLANATION
SYSTEM	Green		ON = System is ready
			BLINK = System is starting up
			OFF = System is not operating
BACK-UP	Green		ON = Back-up is ready / power available
			OFF = Back-up is off / on power available
			OFF = Back-up is off / on power available
BATTERY	Blue		ON = Battery is charging
			BLINK 1 = Battery is discharging
			BLINK 2 = Battery is low / soc is low
			OFF = Battery is disconnected / not active
GRID	Blue		ON = Grid is active and connected
			BLINK = Grid is active but not connected
			OFF = Grid is not active
ENERGY	Yellow		ON = Consuming energy from grid / buying
			BLINK 1 = Supplying energy to grid / zeroing
			BLINK 2 = Supplying energy to grid / selling
			OFF = Grid not connected or system not operating
COM	Blue		ON = BMS and meter communication ok
			BLINK 1 = Meter communication ok, BMS communication fail
			BLINK 2 = BMS communication ok, meter communication fail
			OFF = BMS and meter communication fail
WiFi	Yellow		ON = WiFi connected / active
			BLINK 1 = WiFi system resetting
			BLINK 2 = WiFi not connect to router
			BLINK 4 = WiFi server problem
FAULT	Red		ON = Fault has occurred
			BLINK1 = Overload of back-up / Output / reduce load
			BLINK4 = CT wiring fault
			OFF = No fault

02 Installation Instructions

2.1 Unacceptable Installations

Please avoid the following installations which will damage the system or the Inverter. The following installations should be avoided. Any damage caused will not be covered by the warranty policy.

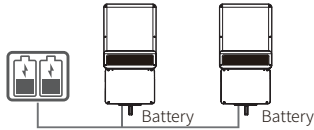

A diagram showing a single battery bank (represented by two battery cells) connected to two separate inverters. Each inverter is labeled "Battery". A red "X" is in the top right corner.

Single battery bank cannot be connected to multiple inverters.

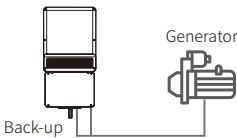

A diagram showing a "Back-up" inverter connected to a "Generator". A red "X" is in the top right corner.

On-Grid or back-up side cannot be connected to any AC generator.

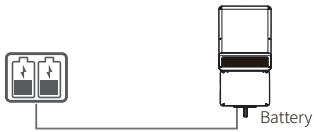

A diagram showing a battery bank connected to an inverter. The battery is labeled "Battery". A red "X" is in the top right corner.

Battery without official compatible statement cannot be connected to inverter.

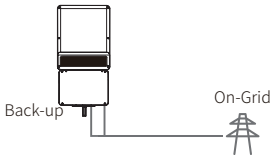

A diagram showing a "Back-up" inverter connected to an "On-Grid" power source, represented by a utility pole. A red "X" is in the top right corner.

Back-up side cannot be connected to grid.

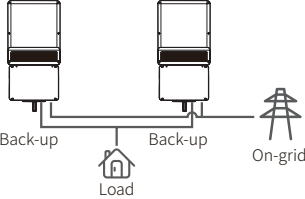

A diagram showing two "Back-up" inverters connected to a "Load" (represented by a house icon) and an "On-grid" power source (represented by a utility pole). A red "X" is in the top right corner.

No parallel connection of the back-up is allowed in general application. Please contact the manufacturer first for advanced application.

2.2 Packing List

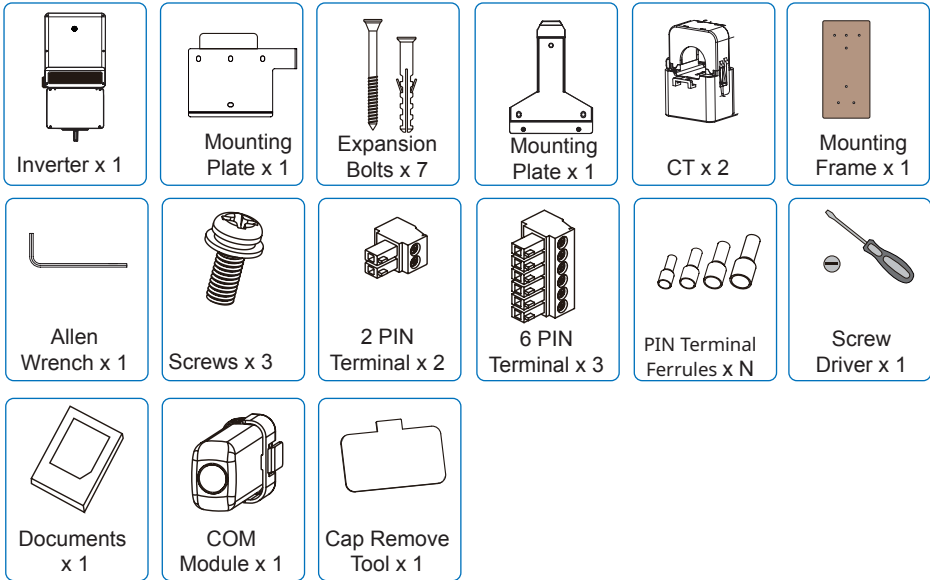

2.3 Mounting

2.3.1 Select Mounting Location

For inverter's protection and convenient maintenance, mounting location for inverter should be selected carefully based on the following rules:

Rule 1. Any part of this system shouldn't block the switch and breaker from disconnecting the inverter from DC and AC power.

Rule 2. Inverter should be installed on a solid surface, where it is suitable for inverter's dimensions and weight.

Rule 3. Inverter should be installed vertically with a max rearward tilt of 15°.

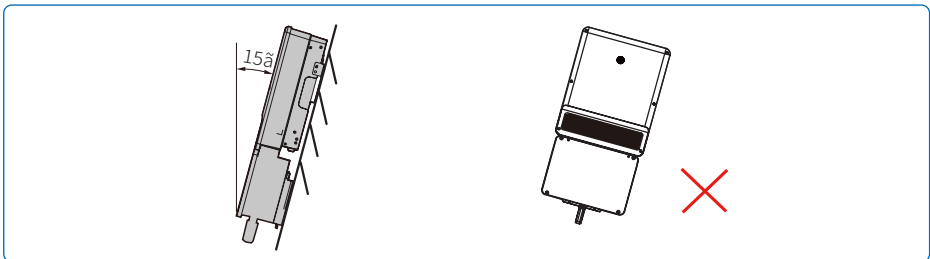

Rule 4. Ambient temperature should be lower than 45°C (113°F).

(High ambient temperature will cause power derating of inverter.)

Rule 5. It is recommended that the installation of the inverter should be prevented from direct sunlight, snow, rain and other negative influences which may cause function impact or life aging.

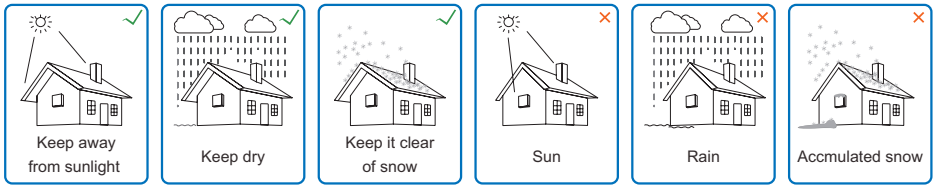

Rule 6. Inverter should be installed at eye level for convenient maintenance.

Rule 7. Product label on inverter should be clearly visible after installation. Do not damage the label.

Rule 8. Do not install the inverter when it is snowing or raining. If you have to, pay attention to the waterproof and moisture-proof of the inverter and distribution box.

Rule 9. Leave enough space around the inverter according to the below figure for natural heat dissipation.

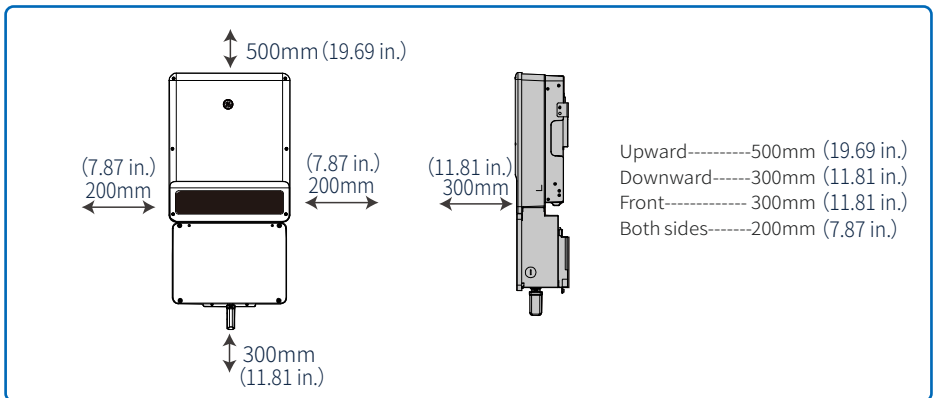

2.3.2 Wall Mounted Bracket And Inverter Installation

Inverter should be installed away from combustible, explosive and strong electro-magnetic materials.

The inverter is suitable for mounting on non-combustible surface only.

L'onduleur doit être installé loin des matériaux électro-magnats combustibles, explosifs et forts.

L'onduleur est adapté au montage sur une surface non combustible seulement.



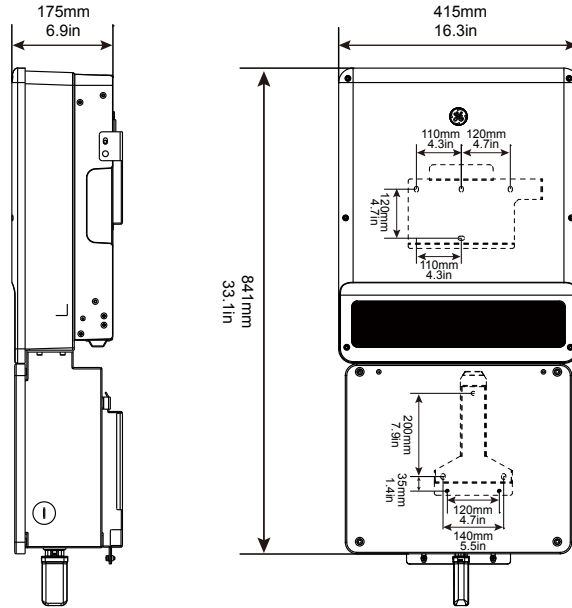

Step 1

Take out the mounting template which is to locate the hole position of the wall mounted brackets.

Fix the mounting template on the wall which is suitable for installation of inverter.

Please drill 7 holes on the wall according to the size on the frame post. (8mm*1 in diameter, and 80mm*2 in depth).

*1. 8mm=0.31 in.

*2. 80mm=3.15 in

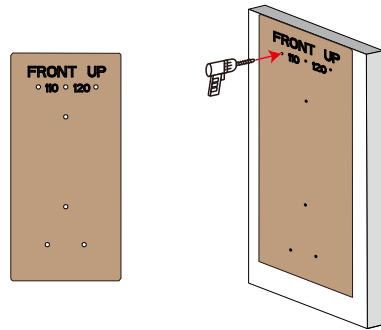

Avoid drilling holes in walls which with cables inside or on the back. Make sure the hole positions are horizontal and vertical.

Évitez de percer des trous dans les murs qui avec des câbles à l'intérieur ou à l'arrière.

Assurez-vous que les positions de trou sont horizontales et verticales.

Step 2

Use expansion bolts in accessory box to fix the wall-mounted bracket onto the wall tightly.

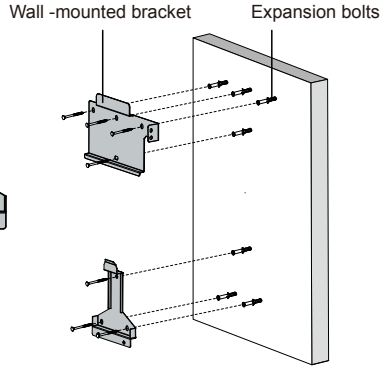
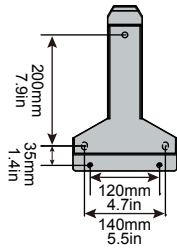
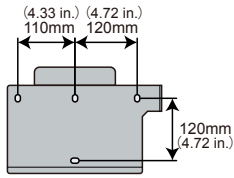

WARNING!

Bearing capacity of the wall must be higher than 100kg(220.46lb), otherwise it may not be able to prevent the inverter from dropping.

La capacité de roulement du mur doit être supérieure à 100 kg(220.46lb), sinon elle pourrait ne pas être en mesure d'empêcher l'onduleur de tomber.

Step 3

Carry the inverter by holding the heatsink on two sides and place the inverter on the wall-mounted bracket. The inverter is heavy, do not carry it by one person.

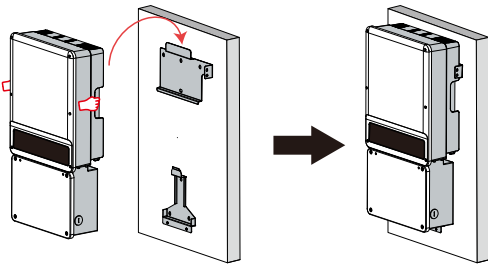

WARNING!

Do not use force beyond the heatsink sides to avoid damage to the inverter. Avoid holding and lifting the wiring box, keep balance of the inverter during moving.

N'utilisez pas la force au-delà des côtés du radiateur pour éviter les dommages causés à l'onduleur.

Évitez de tenir et de soulever l'unité de connexion, de maintenir l'équilibre de l'onduleur pendant le déplacement.

Step 4

Fasten the inverter by fixed screws.(3 positions)

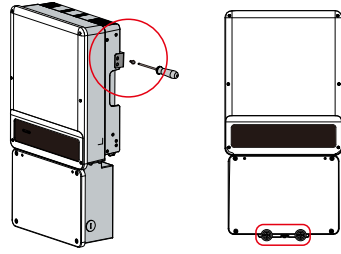

Step 5

Inverter can be locked for prevention of thievery. Lock will not be provided by inverter manufacturer.

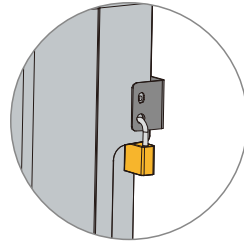

2.4 Conduit and Wiring Installation



Before starting installation or commissioning GEC, please read the following statements carefully.

- During wiring connection, the operator should always wear proper PPE.
- Installation and commissioning must be performed by qualified personnel in accordance with local, state, and National Electrical Code ANSI/NFPA 70 requirements.
- The method and process of installing and wiring connection must comply with all US National Electric Code (NEC) requirement and local AHJ inspector requirements in the United States. Meanwhile in Canada method and process must comply with Canadian Electric Code: Part I and Part II, and the local AHJ inspector requirements.
- The wiring installation must strictly observe correct specification. Otherwise, it may bring waterproof and electrical problems.

Avant de commencer l'installation ou la mise en service de GEC, veuillez lire attentivement les déclarations ci-dessous.

- Pendant la connexion au câblage, l'opérateur doit toujours porter un EPI approprié.
- L'installation et la mise en service doivent être effectuées par un électricien agréé conformément aux exigences locales, étatiques et nationales du Code électrique ANSI/NFPA 70.
- La méthode et le processus d'installation et de connexion au câblage doivent se conformer à toutes les exigences du Code national électrique (NEC) des États-Unis et aux exigences locales des inspecteurs de l'AHJ dans les États-Unis. Pendant ce temps, au Canada, la méthode et le processus doivent être conformes au Code canadien de l'électricité : partie I et partie II, ainsi qu'aux exigences locales des inspecteurs de l'AHJ.
- L'installation de câblage doit observer strictement les spécifications correctes. Sinon, il peut apporter des problèmes imperméables et électriques.

2.4.1 Wiring Box Conduit Plugs

Conduit plugs are provided for 1" diameter conduit fittings. An appropriate conduit adaptor or reducing washers should be applied when conduit fittings with other dimensions are used.

Step 1

Undo the 4 screws of the wiring box cover with the included Allen Wrench and remove the cover.

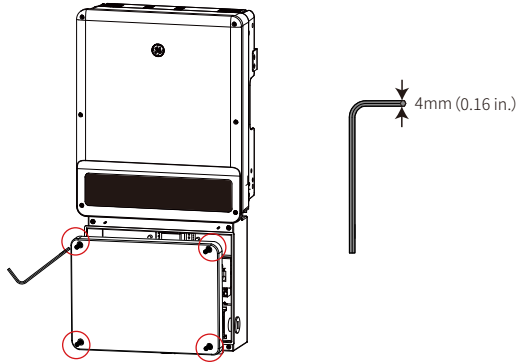

Step 2

Remove the waterproof cover(s) with the included cap removal tool. Remove only those covers on conduit holes to be filled with conduit and fittings.

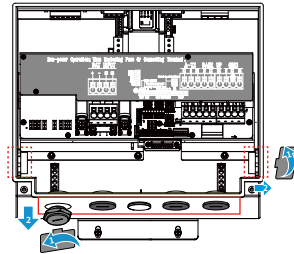

Step 3

Insert the desired conduit or tubing and corresponding adaptors, fittings, and bushings, as appropriate. Tighten the connection.

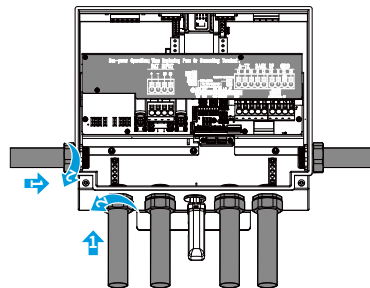

2.4.2 Battery Wiring Connection



Please strictly follow the requirements and steps below or GEC damage or even fire may occur.

- Before connecting the battery cable, make sure that all switches connected to the inverter are turned off (open circuit) and that there is no power left in the inverter.

- Be careful about any electric shock or chemical hazard. Personal injury may be caused by a short circuit of the battery. High transient current will release an energy surge sufficient even cause a fire.
- Do not connect or disconnect battery cable when GEC is running.
- According to the inverter specification for battery input circuit protection, it needs an external DC breaker (70A) connect between battery and inverter. The breaker can also be configured according to the actual maximum operating current of the battery.
- Make sure that the battery switch is off and the open circuit battery voltage is always less than or equal to 500VDC.
- Do not connect load between GEC and battery.
- Using improper wires may cause bad contact and high impedance, which is dangerous to the system.
- Make sure the battery cables are connected correctly. The polarities of battery terminals should match those of the inverter BAT terminals to which they are connected.
- Do not remove the waterproof bolt from any PV input terminals not being used. Doing so may affect the IP/MEMA rating of your GEC inverter.
- Veuillez suivre les exigences et les étapes ci-dessous strictement, ou des dommages GEC ou même un incendie peuvent se produire si elle n'est pas satisfaite des conditions suivantes.
- Avant de connecter le câble de la batterie, assurez-vous que tous les interrupteurs connectés à l'onduleur sont fermés et qu'il n'y a plus de puissance dans l'onduleur.
- Soyez prudent au sujet de tout choc électrique ou danger chimique. Les blessures corporelles peuvent être causées par le circuit de la batterie. Un courant transitoire élevé libérera une surtension d'énergie, même sera en mesure de causer un incendie.
- Ne pas connecter ou déconnecter le câble de la batterie lorsque GEC est en marche.
- Selon les spécifications de l'onduleur pour la protection du circuit d'entrée de la batterie, il a besoin d'un disjoncteur DC externe (70A) se connecter entre la batterie et l'onduleur. Le disjoncteur peut également être configuré en fonction du courant de fonctionnement maximal réel de la batterie.
- Assurez-vous que l'interrupteur de la batterie est éteint et que la tension de la batterie en circuit ouvert est toujours inférieure ou égale à 500VDC.
- Ne connectez pas la charge entre GEC et la batterie.
- L'utilisation de fils inappropriés peut causer un mauvais contact et un obstacle élevé, ce qui est dangereux pour le système.
- Assurez-vous que les câbles de batterie sont connectés correctement. Les polarités de la batterie doivent être connectées en conséquence.
- N'enlevez pas le boulon imperméable à l'eau des terminaux d'entrée DC si les terminaux d'entrée DC de GEC ne sont pas connectés aux chaînes photovoltaïques. Dans le cas contraire, il peut affecter le niveau de propriété intellectuelle de GEC.

Battery wiring connection process

The maximum battery current is 50A; please use 90°C, #6 AWG copper building wire (e.g., THHN, THWN-2, XHHW, or RHH wire).

Do not use aluminum cables .

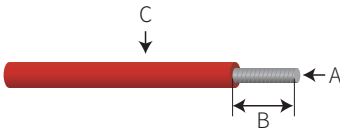

Grade	Description	Value
A	Conductor core section	6AWG
B	Conductor core length	18mm(0.71in.)
C	Outside Diameter	Max 7.4mm(0.29in.)

Step 1

Use the correct wire ferrule from the accessory box. Crimp the ferrule onto the conductor core tightly, as shown below.

Note:

Make sure the cable jacket is not locked within the wire ferrule's crimped section. It is not necessary to utilize a wire ferrule if using a solid (non-stranded) conductor, just remove the insulation.

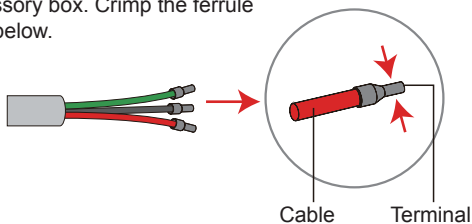

Step 2

Run the AC conductors (N, L1, L2) through a conduit opening located either below or to the right of the GRID terminals. Connect AC conductors to GRID terminals.

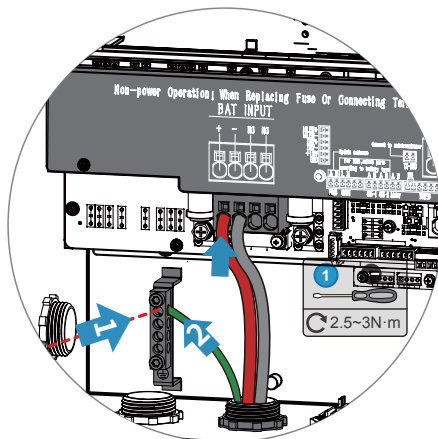
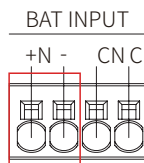

2.4.3 On-Grid / AC Connection

An external AC breaker, usually located in a load panel or solar dedicated AC sub-panel, is needed for an on-grid / AC connection to isolate the inverter from the utility grid when necessary.

Proper specification of an AC circuit breaker for the specific inverter model is advised. Please read the following table for the recommended maximum ampacity rating of the AC circuit breaker and local (AHJ) requirements before selecting a suitable AC circuit breaker.

Inverter Model	Max Ampacity Breaker Rating
GEC5.0-1U-US10	35A
GEC6.0-1U-US10	40A
GEC7.0-1U-US10	45A
GEC7.6-1U-US10	50A
GEC8.6-1U-US10	50A
GEC9.6-1U-US10	50A

Note: The absence of AC breaker will lead to inverter damage if an electrical short circuit happens on grid side.



Make sure the inverter is totally isolated from any DC or AC power before connecting AC cable.
Assurez-vous que l'onduleur est totalement isolé de toute puissance DC ou AC avant de connecter le câble AC.

Please use 90°C, #8-10 AWG copper building wire.
Do not use aluminum cables .

Maximum outside diameter 7.4mm(0.29in.)

Conductor Core Section

Inverter Model	Conductor Core Section(Recommended)
GEC5.0-1U-US10	10AWG
GEC6.0-1U-US10	10AWG
GEC7.0-1U-US10	8AWG
GEC7.6-1U-US10	8AWG
GEC8.6-1U-US10	8AWG
GEC9.6-1U-US10	8AWG

Step 1

Use the right pin terminal from the accessory box. Press the connectors on cable conductor core tightly.

Note:
Make sure cable jacket is not locked within the connector.
It is not necessary to press the terminal if use the hard conductor or single conductor, just remove the insulation.

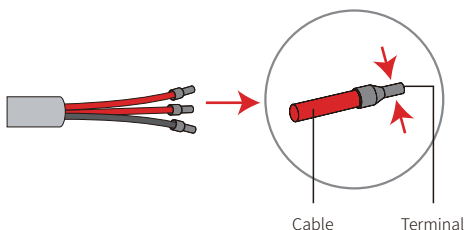

Step 2

Drag the on-grid cables through the On-Grid port.
Connect On-Grid cables to On-Grid terminal.

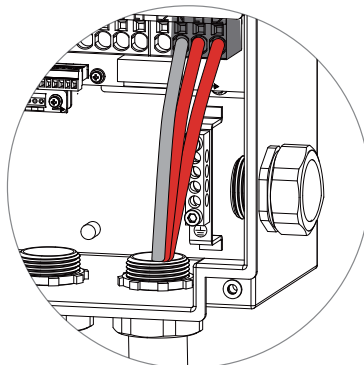
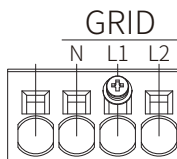

2.4.4 Back-up Connection

Declaration for back-up function

The below statement lays out general policies governing the AC-coupled inverters.

1. The back-up function needs the addition of an auto-transformer for 120V back-up loads. Otherwise, the off-grid function may not be used, and back-up loads may be damaged.

2. Some external factors may cause the system to fail on back-up mode. As such, we recommend the users to be aware of conditions and follow the instructions as below:

- Do not connect loads if they depend on a stable energy supply for a reliable operation.
- Do not connect the loads which may in total exceed the maximum back-up capacity.
- Try to avoid those loads which may create very high start-up current surges such as Inverter Air-conditioner, high-power pump etc.
- Due to the condition of battery itself, battery current might be limited by some factors including but not limited to the temperature, weather etc.

Micro-grid system configuration

When GEC detects the charging power in off-grid mode, it will turn on micro-grid mode. In order to ensure the stability of a micro-grid, the system configuration must meet the following rules.

1. A micro-grid system only supports one PV inverter.
2. If the PV panel and PV inverter have been installed, when you select the capacity of GEC and battery, please satisfy the following constraint formula.

$$\begin{aligned} P_{GEC} > P_{PVInverter} \quad [1] \\ \text{Min}\{ \text{Min}\{ \text{Min}\{ V_{BAT} \} * \text{Min}\{ \text{Max}\{ I_{BAT_Chg}, \text{Max}\{ I_{GEC_BatChg} \} \} \} \} > \text{Min}\{ P_{Panel}, P_{PVInverter} \} \quad [2] \\ \text{Min}\{ V_{BAT} \} * \text{Min}\{ \text{Max}\{ I_{BAT_Chg}, \text{Max}\{ I_{GEC_BatChg} \} \} \} = \text{Minimum rechargeable power of the battery} \end{aligned}$$

P_{GEC} : Rated Power of GEC

$P_{PVInverter}$: Rated Power of the PV Inverter

P_{Panel} : Rated Power of the Panel

$\text{Min}\{ V_{BAT} \}$: Minimum Output Voltage of the Battery

$\text{Max}\{ I_{BAT_Chg} \}$: Maximum Charging Current of the Battery

$\text{Max}\{ I_{GEC_BatChg} \}$: Maximum Battery Charging Current of GEC

For example, a set of 7KW PV panel + 7.6KW PV inverter system has been installed, you must choose 8.6KW or 9.6KW GEC. At the same time, the theoretical minimum rechargeable power of the battery only needs to be greater than 7KW.

3. The battery voltage in the micro-grid system must not be higher than 405V.
4. The PV inverter must respond to the following Frequency-Watt curve.

Frequency-Watt curve

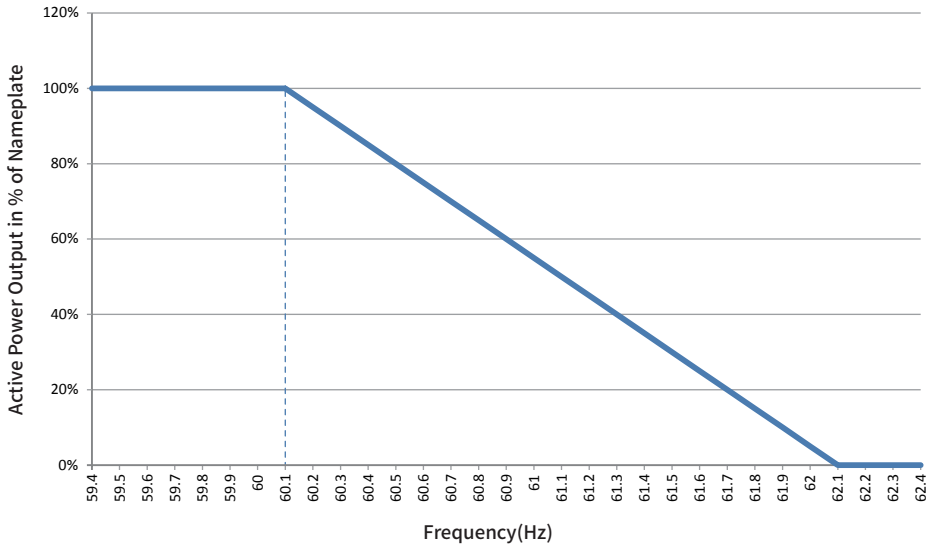

Micro grid frequency shift

When the battery SOC is high and the charging power is detected, GEC will increase the output frequency, causing the PV inverter to reduce the output power, until the battery enters a low-power discharge state.

Declaration for back-up loads

GEC series AC-COUPLED inverters are able to supply overload power output at its Back-Up terminals. For details, please refer to the Technical Parameters in section 3.4. However, this inverter has self-protection derating at high ambient temperature.

Declaration for back-up overload protection

The inverter will restart itself as overload protection happens. The preparation time for restarting will be longer and longer (max one hour) if overload protection repeats. Take the following steps to restart inverter immediately instead of waiting for delayed restart.

- Decrease back-up load power within max limitation.
- On Storage Mate → Advanced Setting → Click "Reset back-up Overload History"

Accepted loads as below:

Common household loads can be used normally; for specific loads, please refer to following section.

- Inductive Load: 2P non-frequency conversion air-conditioners can be connected to the Back-up side. More than 2 non-frequency conversion air-conditioners connected to Back-up side may cause UPS mode to be unstable.
- Capacitive Load: Total power $\leq 0.6 \times$ nominal power of model. (Any load with high startup current at start-up is not accepted.)
- For complicated applications, please contact the Global Call Center for support.

An external AC breaker is needed for back-up connection to be isolated when necessary.

Back-up Connection



Make sure the inverter is totally isolated from any DC or AC power before connecting back-up cable.

Assurez-vous que l'onduleur est totalement isolé de toute puissance DC ou AC avant de connecter le câble de back-up.

When using the back-up function of the inverter, corresponding protective devices like AC breaker should be applied to ensure safety or satisfy local requirement.

Inverter Model	AC breaker specification
GEC5.0-1U-US10	30A
GEC6.0-1U-US10	40A
GEC7.0-1U-US10	45A
GEC7.6-1U-US10	50A
GEC8.6-1U-US10	50A
GEC9.6-1U-US10	50A

Note: The absence of an AC breaker on the back-up side will lead to inverter damage if an electrical short-circuit happened on the Back-up side. The Back-up function cannot turn off under On-Grid condition.

Back-up Load Configuration

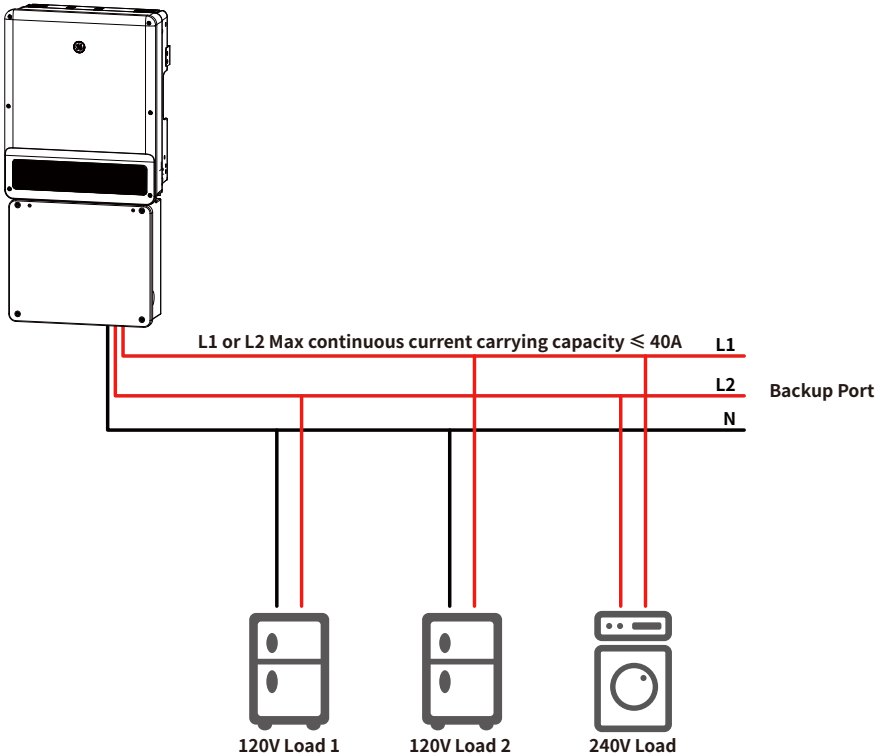

Case1. If there is no 240V Load, both 120V Load 1 and Load 2 individually have a total Max power $\leq 5\text{kVA}$.

Case2. If there is only a 240V Load and no 120V loads, inverter output power $\leq 10\text{kVA}$.

Case3. If there is 240V Load with a power draw = P1, then any 120V load has a maximum power $\leq (10-P1)/2 \text{ kVA}$.

Note:

The 120V and 240V load configuration of the auto-transformer should meet the below requirements. It is stipulated that the 120V load received by L1-N and L2-N do not exceed 5kW respectively. If there is a 240V load, 240V load power needs to be subtracted and distributed equally. For example, 240V load power is P1, then $(10\text{kW}-P1) / 2$ is the remaining 120V power of the L1-N and L2-N back-up circuits. The imbalance load cannot exceed the new power distribution.

L1-N: AC power provided between L1 leg and Neutral line

L2-N: AC power provided between L2 leg and Neutral line

Back-up wiring connection process



To reduce the risk of fire, do not connect the wires to an AC load center or circuit breaker panel which have too many cables connected.

Pour réduire le risque d'incendie, ne vous connectez pas à un centre de chargement AC (panneau de disjoncteur) ayant des circuits de branche multi-fil connectés.

The maximum back-up current is 40A. Please use 90°C wire, 8-10AWG copper.

Do not use aluminum cables .

Maximum outside diameter 7.4mm(0.29in.)

Inverter Model	Conductor Core Section(Recommended)
GEC5.0-1U-US10	10AWG
GEC6.0-1U-US10	10AWG
GEC7.0-1U-US10	8AWG
GEC7.6-1U-US10	8AWG
GEC8.6-1U-US10	8AWG
GEC9.6-1U-US10	8AWG

Step 1

Use the correct wire ferrule from the accessory box. Crimp the ferrule onto the conductor core tightly, as shown below.

Note:

Mak sure the cable jacket is not locked within the wire ferrule's crimped section. It is not necessary to utilize a wire ferrule if using a solid (non-stranded) conductor; just remove the insulation.

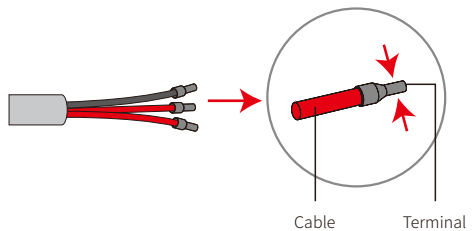

Step 2

Run the Back-up conductors (N, L1, L2) through a conduit opening located either below the BACK UP terminals. Connect the Back-up AC conductors to BACK UP terminals.

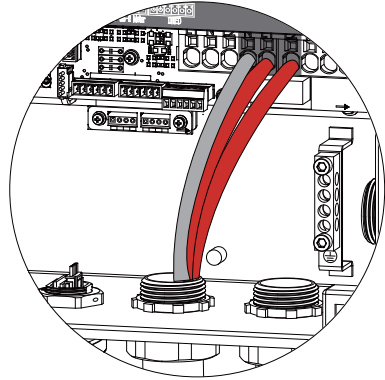
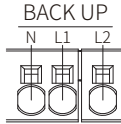

2.4.5 Auto-transformer Connection (Optional)

The off-grid functions can be used only after the auto-transformer is installed.



The auto-transformer cannot be installed near flammable, explosive or strong electro-magnetic equipment.

L'auto-transformateur ne peut pas être installé près de l'équipement électromagnétique inflammable, explosif ou solide.

Leave enough space around the auto-transformer according to the below figure for natural heat dissipation.

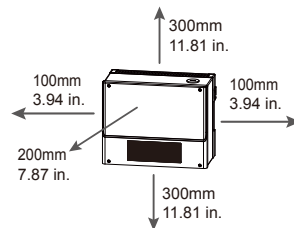
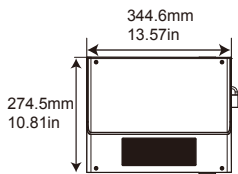

Step 1

Use the wall-mounted bracket as a template and drill holes in the wall, 10mm(0.39 in.) in diameter and 80mm(3.15 in.) deep. Fix the wall-mounted bracket on the wall using the expansion bolts in the accessories bag.

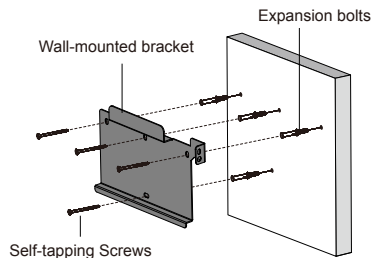
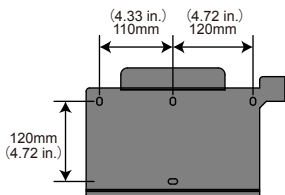

Step 2

Carry the auto-transformer by holding the heatsink on two sides and place the equipment on the mounting bracket.

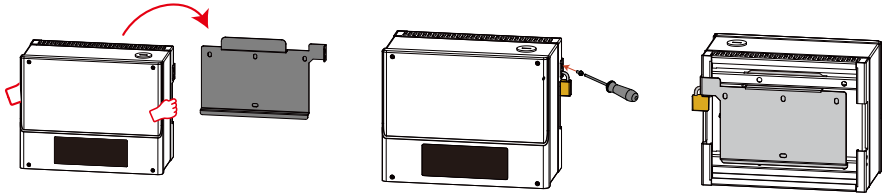

CAUTION!

The auto-transformer is small in size, but very heavy. It is recommended that two people carry it during installation.
L'auto-transformateur est de petite taille, mais très lourd. Il est recommandé que deux personnes le portent pendant l'installation.

Auto-transformer wiring connection

Step 1

Using the included 3mm Allen wrench, remove the 4 screws of the auto-transformer and remove the cover.

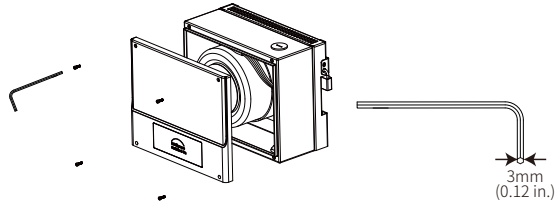

Step 2

Remove the waterproof conduit hole cover with the included cap removal tool.

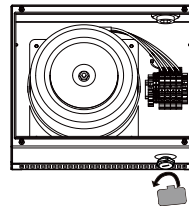

Please use 90°C, #8-10 AWG copper building wire.
Do not use aluminum cables .

Maximum outside diameter 7.4mm(0.29in.)

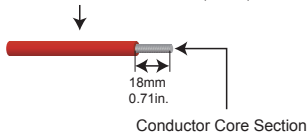

Conductor Core Section

Inverter Model	Conductor Core Section(Recommended)
GEC5.0-1U-US10	10AWG
GEC6.0-1U-US10	10AWG
GEC7.0-1U-US10	8AWG
GEC7.6-1U-US10	8AWG
GEC8.6-1U-US10	8AWG
GEC9.6-1U-US10	8AWG

Step 3

The temperature sensor ('NTC') connection to the auto-transformer uses a pair of #22 or #24 AWG, 600V insulated wires. One end connects with a 2-pin 'A-TX' terminal inside the inverter, and the other end is crimped with the smallest wire ferrule in the accessory box and connected to the auto-transformer 'NTC' terminal.

Use the correct wire ferrule from the accessory box. Crimp the wire ferrule onto each conductor (L1, N, L2) core tightly.

Note:

Make sure the cable jacket is not locked within the wire ferrule's crimped section. It is not necessary to utilize a wire ferrule if using a solid (non-stranded) conductor; just remove the insulation.

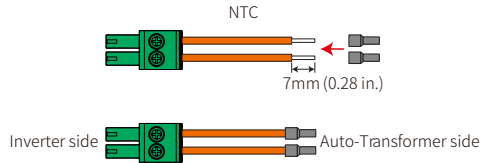
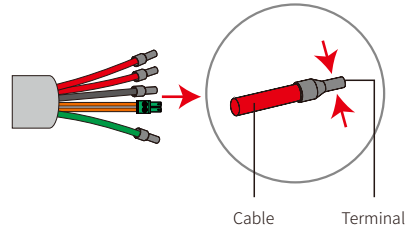

Step 4

Run the NTC, power, and ground (PE) wires through auto-transformer conduit. Connect power conductors to the ATX terminals (L1, N, L2). Connect the green ground wire to the GND/PE terminal. Connect the 2-Pin terminal to TXNTC.

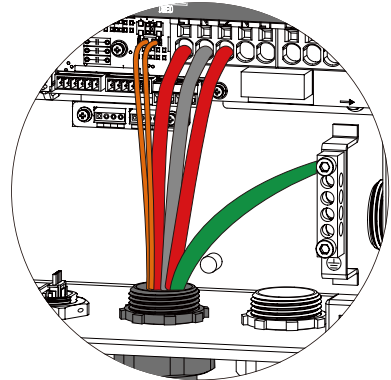
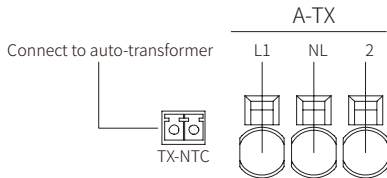

Step 5

Pass the A-TX (L1, N, L2), ground (PE), and NTC wires through the auto-transformer conduit entrance as pictured.

Secure the conduit fitting.

Run the wires to the auto-transformer port and connect as shown.

After installation, secure the auto-transformer cover with the 4 screws.

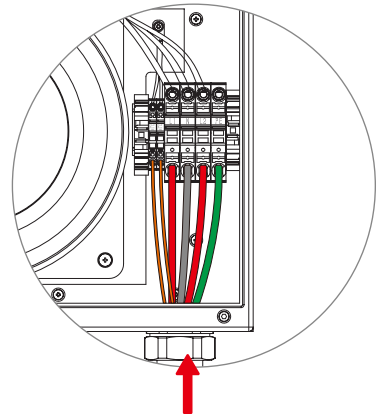
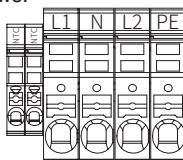

2.4.6 CT Connections

The two split-core current transformers (CTs) in product box must be installed for the system to detect AC Mains current direction and magnitude; this data instructs the operation of GEC inverter based on operating mode.

Note:

1. The Smart Meter with CT is well configured, please do not change any setting on the Smart Meter.
2. Each CT must be connected on a separate phase (e.g., L1 and L2)
3. Please use only the 2 CTs in the accessory box.
4. The CT cable is 10m (32.8 ft) as default.
5. CT cable can be extended to a maximum of 30m (98.4 ft), contact the support department to achieve the maximum cable length.



If connecting CT's to the line side of the main break, make sure the AC conductors (L1 and L2) are totally isolated from AC power before connecting a CT to each.
Assurez-vous que le câble AC est totalement isolé de la puissance AC avant de connecter CT.

Step 1

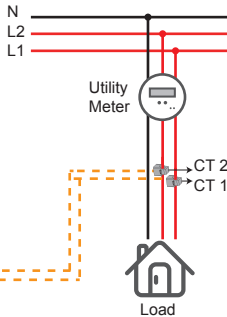
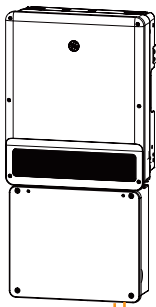

Connect CT1 and CT2 in the accessories box to the corresponding line at the service entrance.



CT 1 connect to L1
CT 2 connect to L2

Step 2

Pass the other end of the CT through the CT port and insert the 4-Pin terminal to the "Connect to CT"

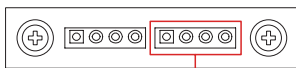

Connect to CT

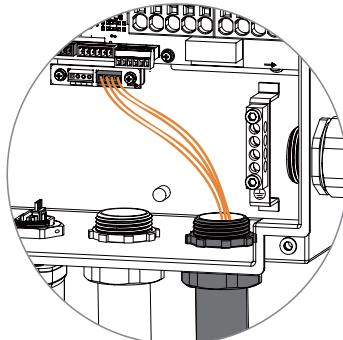

2.4.7 Battery BMS Connection

There are two serial communication options for the battery BMS (Battery management system) of the GEC series:

- Controller Area Network (CAN) 1 communication (e.g., for BYD battery)
- RS-485 communication ('485 network') (e.g., for LG battery)

Select the corresponding communication according to the battery type installed.

The BMS uses a #22 AWG, 600V insulated cable.

Step 1

Use the right pin terminal from the accessory box. Press the connectors on cable conductor core tightly.

Note:

Make sure cable jacket is not locked within the connector.

It is not necessary to press the terminal if use the hard conductor or single conductor, just remove the insulation.

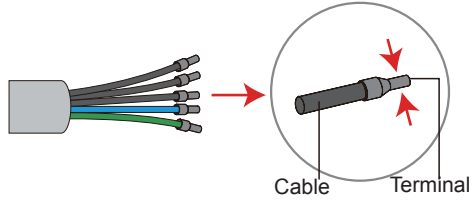

Step 2

Run the cables through the BMS conduit port. Tighten conduit fitting of BMS port.

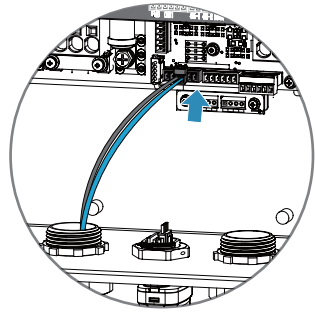
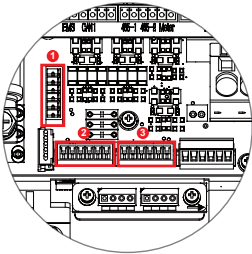

Step 3

For CAN1 battery, for example BYD, please connect BMS cables to CAN1 terminals as shown in position 2 in the figure.



For LG battery, please connect BMS cables to 485-1 terminals and connect enable signal cables to LG_EN+ & LG_EN- as shown in position 1 and 3 in the figure.

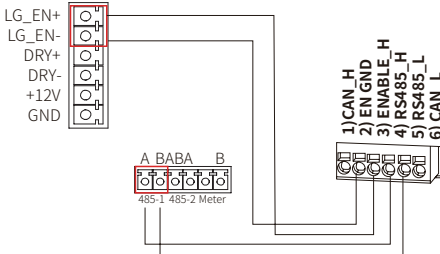

GEC Connector	LG Battery Connector
NC	CAN_H
LG_EN+	EN_GND
LG_EN-	ENABLE_H
485-1A	RS485_H
485-1B	RS485_L
NC	CAN_L

Step 4

After all the wiring is connected, please reattach the wiring distribution box cover; ensure that water waterproof fittings are used and that the conduit/tubing will not channel water into the wiring compartment.

Note: the wiring box cover fits only one way according to 2 pins and matching holes across the top that must line up.

2.4.8 WiFi Communication Connection

After completing installation and wiring connection, please refer to “WiFi Configuration Instruction” in the accessory box to complete the WiFi configuration.

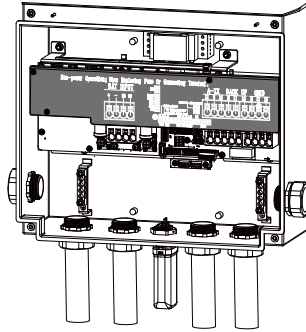

Plug the WiFi module into the Wifi terminal.

2.5 Storage Mate App

Storage Mate is an external monitoring/ configuration application for AC-COUPLED inverters, used on smart phones or tablet for both Android and iOS system. Main functions are as below:

1. Edit system configuration to make the system work as customer needs.
2. Monitor and check the performance of the AC-COUPLED system.
3. Wi-Fi configuration.

Search Storage Mate in Google Play or APP Store.

Set safty parameters, such as PU curve, QU curve, voltage and frequency protection parameters, and other adjustable parameters via Storage Mate App. For more operations in detail, refer to the Storage Mate User Manual.

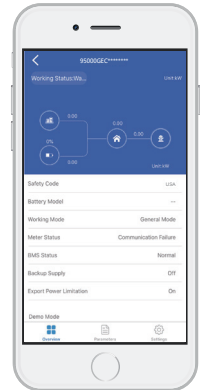

2.6 Wiring System For GEC Series Inverter (Full Backup)

This diagram is an example for US Split grid system.

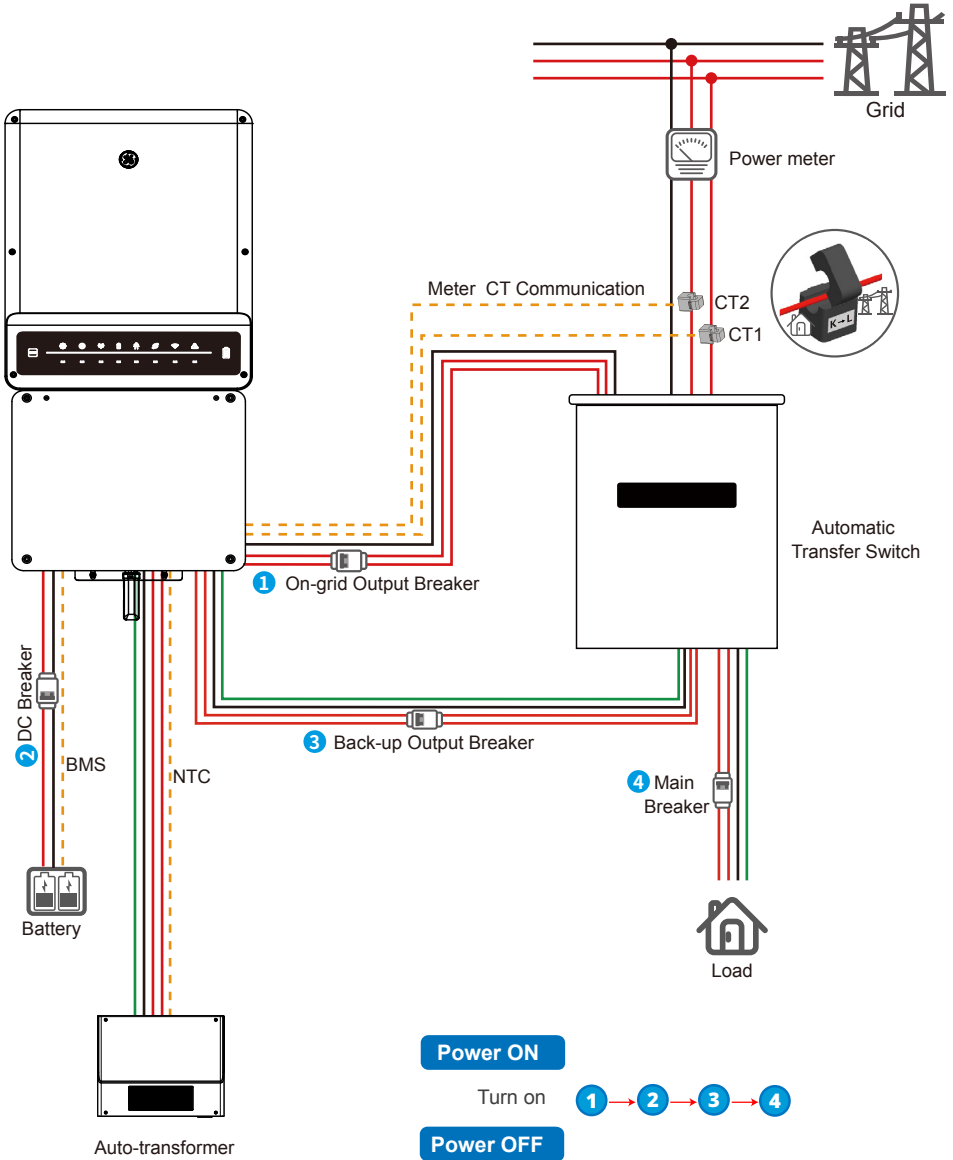

Wiring Box Of GEC Series AC Coupled Inverter (Full Load)

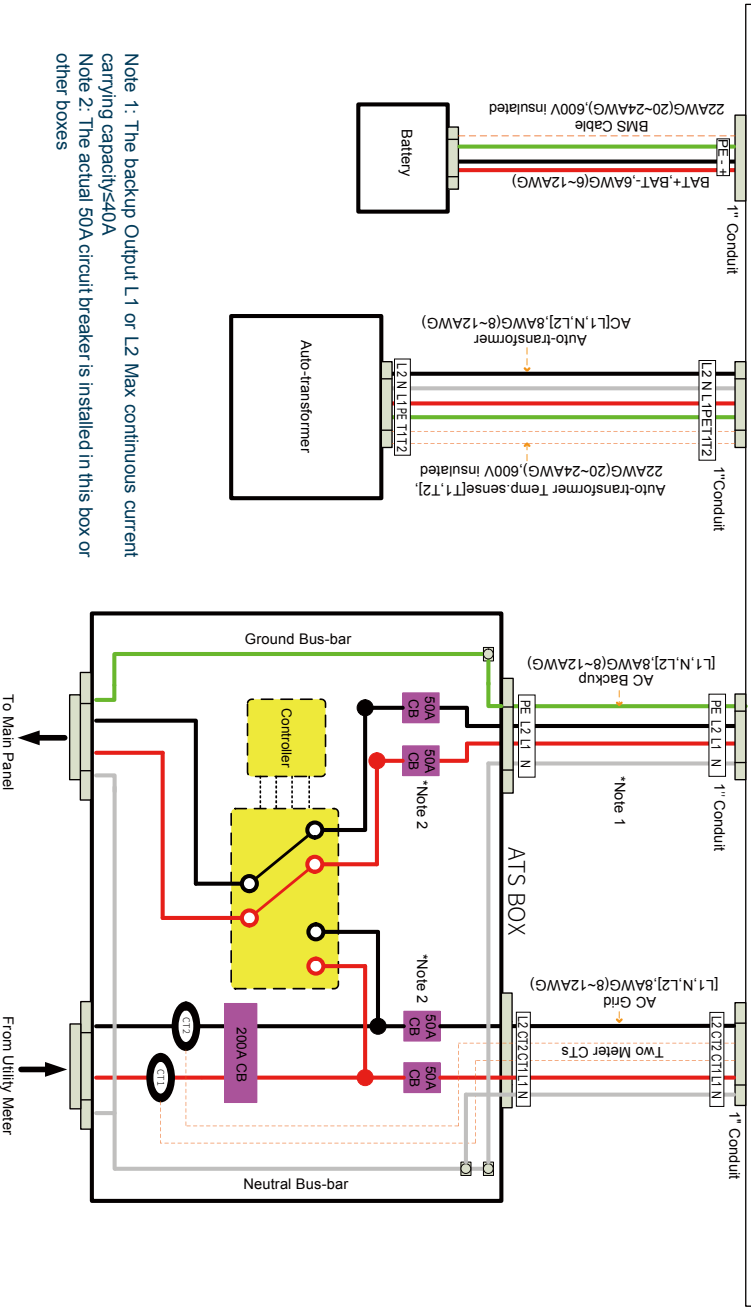

2.7 Wiring System For GEC Series Inverter(Partial Backup)

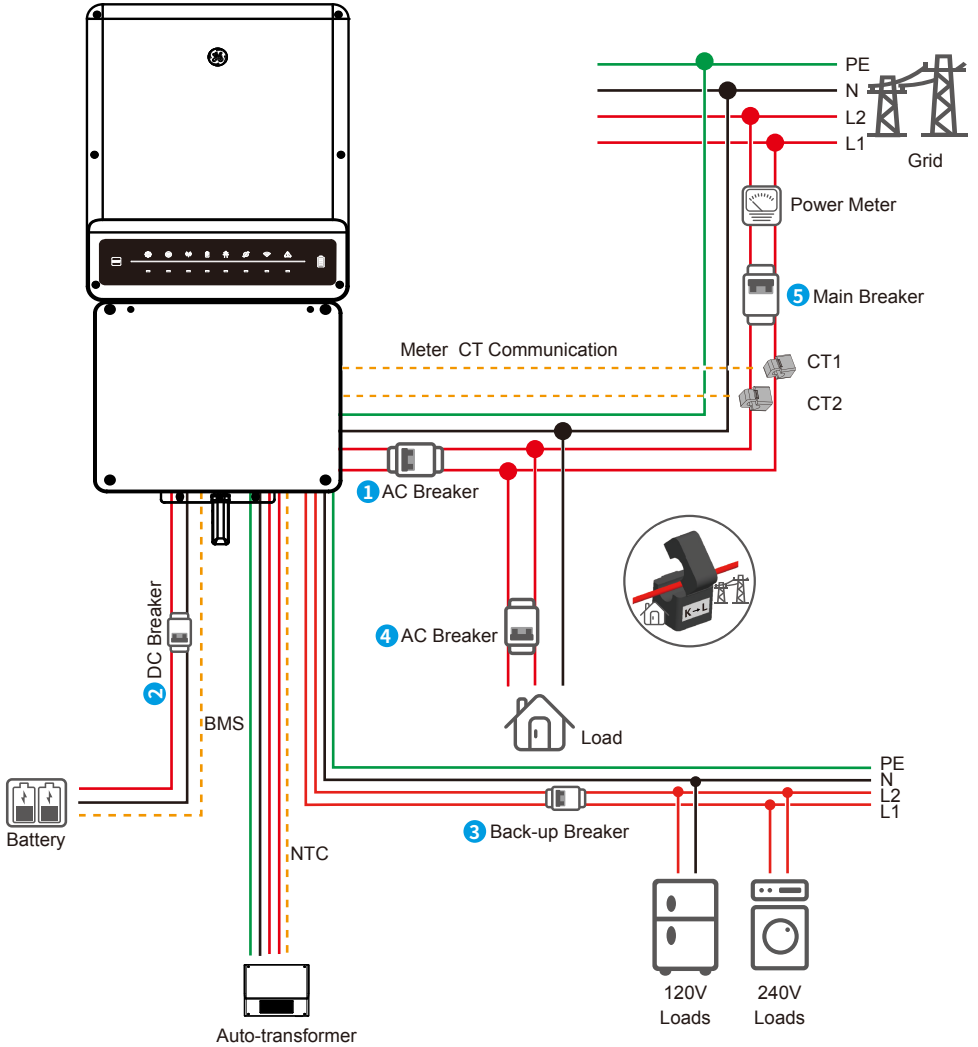

Power ON

Turn on **5** → **1** → **2** → **3** → **4**

Power OFF

Turn off **3** → **4** → **1** → **5** → **2**

Wiring Box Of GEC Series AC Coupled Inverter (Partial Load)

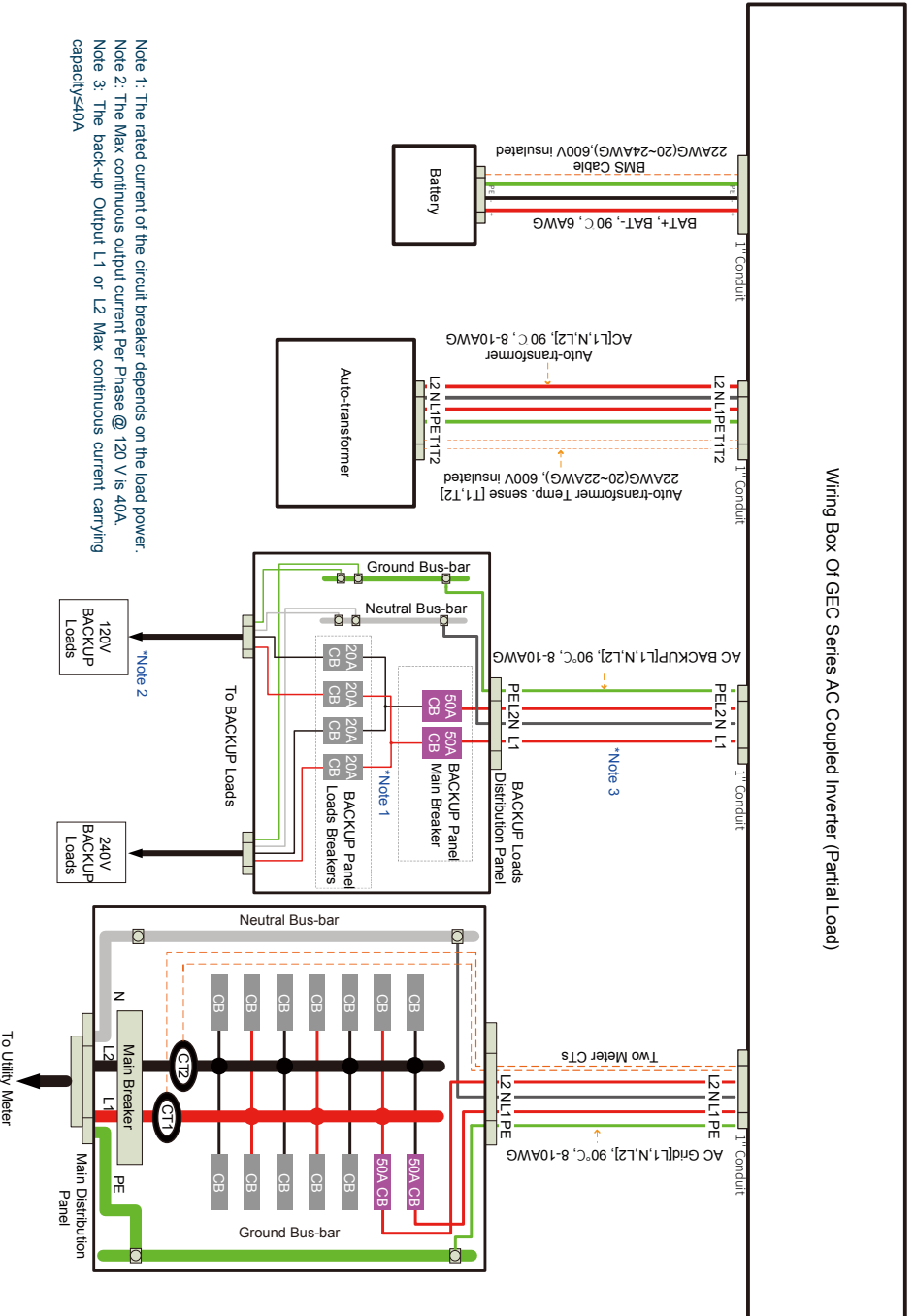

03 OTHER

3.1 Error Messages

The error messages below will be displayed on Storage Mate App or reported by e-mail if an error occurs.

ERROR MESSAGE	EXPLANATION	REASON	SOLUTIONS
Utility Loss	Public grid power is not available (power lost or on-grid connection fails)	Inverter does not detect the connection of grid	<ol style="list-style-type: none"> 1. Check (use multi-meter) if AC side has voltage . Make sure grid power is available. 2. Make sure AC cables are connected tightly and well. 3. If all is well, please try to turn off AC breaker and turn on again in 5 mins.
VAC Failure	Grid voltage is not within permissible range	Inverter detects that AC voltage is beyond the normal range required by the safety country	<ol style="list-style-type: none"> 1. Make sure safety country of the inverter is set right. 2. Check (use multi-meter) if the AC voltage (Between L & N) is within a normal range (also on AC breaker side) <ol style="list-style-type: none"> a. If the AC voltage is high, then make sure the AC cable complies with that required on user manual and the AC cable is not too long. b. If the voltage is low, make sure the AC cable is connected well and the jacket of the AC cable is not compressed into the AC terminal. 3. Make sure the grid voltage of your area is stable and within normal range.
FAC Failure	Grid frequency is not within permissible range	Inverter detects that the grid frequency is beyond the normal range required by the safety country	<ol style="list-style-type: none"> 1. Make sure the safety country of the inverter is set right. 2. If safety country is right, then please check on the inverter display if AC frequency (Fac) is within a normal range. 3. If FAC failure only appears a few times and is resolved soon, it should be caused by occasional grid frequency instability.
Over Temperature	Temperature inside of the inverter is too high	The inverter's working environment leads to a high temperature condition	<ol style="list-style-type: none"> 1. Try to decrease surrounding temperature. 2. Make sure the installation complies with the instruction on inverter user manual. 3. Try to close the inverter for 15 mins, then start up again.

ERROR MESSAGE	EXPLANATION	REASON	SOLUTIONS
Ground I Failure	Ground leakage current is too high	Ground failure could be caused by multiple reasons like that the neutral cable on the AC side is not connected well or the surrounding humidity is comparatively heavy, etc.	Check (use multi-meter) if there is voltage (normally should be close to 0V) between earth & inverter frame. If there is a voltage, it means the neutral & ground cables are not connected well on the AC side. If it happens only in the early morning/dawn /rainy days with higher air humidity and is recovered soon, it should be normal.
Relay Check Failure	Self checking of relay failure	Neutral & ground cables are not connected well on AC side or just an occasional failure	Check (use multi-meter) if there is high voltage (normally should be lower than 10V) between N & PE cable on the AC side. If the voltage is higher than 10V, it means the Neutral & ground cable are not connected well on AC side or restart inverter.
DC Injection High	/	The inverter detects a higher DC component in AC output	Try to restart the inverter,check if it still occurs.If not,it is just an occasional situation.Otherwise, contact after-sales immediately.
EEPROM R/W Failure	/	Caused by a strong external magnetic field etc.	Try to restart the inverter,check if it still occurs.If not,it is just an occasional situation.Otherwise, contact after-sales immediately.
SPI Failure	Internal communication failure	Caused by a strong external magnetic field etc.	Try to restart the inverter,check if it still occurs.If not,it is just an occasional situation.Otherwise, contact after-sales immediately.
DC Bus High	BUS voltage is over-high	/	Try to restart the inverter. Check if the fault still occurs. If not, it means it is caused by an occasional situation,or contact after-sales.
Back-Up Over Load	Back-up side is over loaded	Total back-up load power is higher than the back-up nominal output power	Decrease back-up loads to make sure the total load power is lower than back-up nominal output power (please refer to 2.4.4 Back-up Connection).
AC HCT Check Failure	The inverter's AC HCT check failure.	Inverter hardware current sensor failure.	Try to restart the inverter. Check if the fault still occurs. If not, it means it is caused by an occasional situation,or contact after-sales.

ERROR MESSAGE	EXPLANATION	REASON	SOLUTIONS
GFCI Device Check Failure	GFCI Device Check Failure	GFCI device failure	Try to restart the inverter. Check if the fault still occurs. If not, it means it is caused by an occasional situation, or contact after-sales.

3.2 Troubleshooting

Checking As Start GEC Up And Turn On AC Power

Battery settings, BMS communication and safety country:

After connecting Solar-WiFi* (*The Wi-Fi signal is named the last 8 characters of the inverter's serial No.), check on Storage Mate App "Param" to make sure battery type is the same as what you have installed, and "Safety Country " Setting is right. Please set it right in "Set" if the setting is not right.

Note: For compatible lithium batteries, BMS status will display "Normal" after selecting the right battery company.

Functional Safety: The software version is displayed on Storage Mate App "Param"→"Firmware Version".

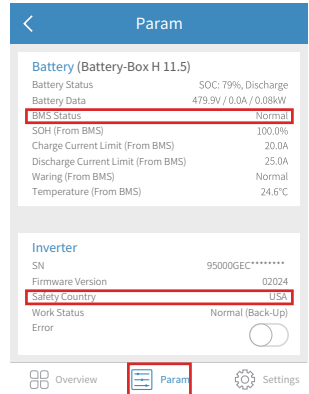

Problems During Operation

GEC does not start up with battery only

Solution:

Make sure the voltage of battery is higher than 100V, otherwise battery cannot start GEC up.

GEC AC-COUPLED inverter doesn't discharge or output.

Solution:

- To check whether the CT is installed correctly, Meter test can be performed in Storage Mate
- Make sure load power is higher than 100W.
 - Battery will not discharge continuously unless load power is higher than 100W;
 - If battery does not discharge when Meter power is higher than 100W, please check CT connection and direction;
- Make sure SOC (State of charge) is higher than 1-DOD (Depth of discharge).
- Check on App whether the charge time has already been set, as during charge time, battery will not discharge (battery will charge in priority during coincident time of charge/discharge).

High power fluctuation on battery charge or discharge

Solution:

Check if there is a fluctuation on load power.

Battery does not charge

Solution:

- Make sure BMS communication is OK on Storage Mate App.
- Check if CT is connected in the right position and connected to right direction and right phase.

The PV inverter in a micro grid system has no output power

Solution:

1. Confirm that GEC outputs normal AC voltage.
2. Confirm whether the PV inverter has the anti-reverse function turned on. Once it is turned on, there may be no power output. You can temporarily turn off the anti-reverse function at this time, and turn off this function after the utility grid is restored.

Questions & Answers (Q & A)

About Wi-Fi Configuration

Q: Why can't I connect Solar-WiFi* signal on my phone?

A: The Wifi module can only connect to one device at a time. If the signal is already connected to another device at the time for some reason, you cannot connect to the signal.

About Battery Operation

Q: Why does the battery not discharge when grid is not available, while it discharges normally when grid is available?

A: On the App, off-grid output and back-up function should be turned on to make battery discharge under off-grid mode.

Q: Why is there no output on back-up side?

A: For back-up supply, the "Back-Up Supply" on Storage Mate App must be turned on. Under off-grid mode or when grid power is disconnected, "Off-Grid Output Switch" function must be turned on as well.

Note: When turning "Off-Grid Output Switch" on, don't restart inverter or battery, otherwise the function will be switched off automatically.

Q: The battery cannot be fully charged to 100%?

A: Battery will stop charging when battery BMS send charge current to zero.

Q: Why battery switch always trip when it starts up?

A: The switch of lithium battery normally trips because of following reasons:

1. BMS communication fails.
2. Battery SOC is too low, battery trips to protect itself.
3. An electrical short-cut happened on battery connection side. Or for other reasons please contact after-sales.

Q: Which battery should I use for GEC?

A: For GEC series inverter, it could connect lithium batteries which have compatibility with GEC series inverter with nominal voltage from 80V to 495V. For compatible lithium batteries please refer to battery list in Storage Mate App.

About Storage Mate Operation And Monitoring

Q: Why can't I save settings on Storage Mate App?

A: It could be caused by losing connection to Solar-WiFi *.

1. Make sure you have already connected Solar-WiFi* (make sure no other devices connected) or router (if connected Solar-WiFi* to router). App's homepage shows connection well.
2. Make sure you restart inverter 10mins after you change some settings because inverter will save settings every 10 mins under normal mode. We recommend to change setting parameters when inverter is in wait mode.

Q: Why are the data displayed on the homepage different from the param page, like charge/discharge, load value or grid value?

A: The data refresh frequency is different, so there will be a data inconformity between different pages on App as well as between these on portal and App.

Q: Some columns show NA, like battery SOH, etc. Why does that happen?

A: NA means App does not receive data from inverter or server because of communication problem, such as battery communication, and communication between inverter and the App.

About Smart Meter And Power Limit Function

Q: How to activate anti-reverse function?

A: For GEC system, the function could be realized by turning on anti-reverse function on App.

Note: Even if this function is turned on, there might still be a deviation of a max of 100W exporting to grid.

Q: Why is there still power exporting to grid after I set power limit as 0W?

A: Export limit could be 0W theoretically, but there will be a deviation of around 50-100W for GEC system.

Q: Can I use other brand CT to take over in GEC system?

A: No, because the CT ratio and Meter are well matched, the accuracy and data accuracy cannot be guaranteed by replacing with other CT

Q: What is the maximum current allowed to go through CT on Smart Meter?

A: The max current for CT is 200A.

Q: In off-grid mode, if the PV energy is sufficient but the battery SOC is low and the GEC cannot output AC voltage, what should I do?

A: Turn off the household load below 200W, turn on the microgrid forced wakeup function on APP, and wait for the PV inverter to work to charge the battery.

Other Questions

Q: Is there a quick way to make the system work?

A: For the shortest way, please refer to "GEC Quick Installation Instructions" and "Storage Mate App Instruction".

Q: What kind of load can i use to connect on back-up side?

A: Please refer to user manual on page19.

Q: Will the warranty of the inverter still be valid if for some special conditions we cannot 100% follow the user manual instructions on the installation or operation?

A: Normally we still provide technical support to problems caused from disobeying the instructions on the user manual, however we cannot guarantee any replacements or returns. So if there is any special conditions where you cannot 100% follow the instructions, please contact after-sales for suggestions.

3.3 Disclaimer

The GEC series inverters are transported, used and operated under environmental and electrical conditions. Manufacturer has the right not to provide after-sales services or assistance under following conditions:

- Inverter is damaged during transfer.
- Inverter is out of warranty year and extended warranty is not bought.
- Inverter is installed, refitted or operated in improper ways without authority from manufacturer.
- Inverter is installed or used under improper environment or technical condition mentioned in this user manual, without authority from manufacturer.
- Installation or configuration of the inverter does not follow requirements mentioned in this user manual.
- The inverter is installed or operated against the requirements or warnings that are mentioned in this user manual.
- Inverter is broken or damaged by any force majeure like lightning, earthquake, fire hazard, storm and volcanic eruption etc.
- Inverter is disassembled, changed or updated on software or hardware without authority from manufacturer.
- Inverter is installed, used or operated against any related items in international or local policies or regulations.
- Any non-compatible batteries, loads or other devices connected to GEC system.

Note: Manufacturer will keep the right to explain all the contents in this user manual. To insure NEMA Type 4X, inverter must be sealed well, please install the inverters within one day after unpacking, otherwise please seal all unused terminals / holes, unused terminals / holes are not allowed to be kept open, confirm that there is no risk of water or dust entering the terminals / holes.

3.4 Technical Parameters

3.4.1 Inverter Specification

Technical Data	GEC5.0-1U-US10	GEC6.0-1U-US10	GEC7.0-1U-US10
Battery Input Data			
Battery Type	Li-Ion		
Nominal Battery Voltage (V)	300		
Battery Voltage Range (V) ¹	80~495		
Max Continuous Charging Current(A)	50		
Max Continuous Discharging Current (A)	50		
Max Charge Power (W)	5000	6000	7000
Max Discharge Power (W)	5000	6000	7000
AC Output Data (On-grid)			
Nominal Apparent Power Output to Utility Grid (VA)	5000	6000	7000
Max. Apparent Power Output to Utility Grid (VA)	5000	6000	7000
Nominal Apparent Power from Grid (VA)	5000	6000	7000
Max. Apparent Power from Utility Grid (VA)	6000	7200	8400
Nominal Output Voltage (V)	120/240		
Output Voltage Range (V)	211 to 264 @240		
Nominal AC Grid Frequency (Hz)	60		
AC Grid Frequency Range (Hz)	50-66Hz		
Max. AC Current Output to Utility Grid (A)	20.8	25	29.2
Max. AC Current From Utility Grid (A)	25	30	35
Nominal Output Current (A)	20.8	25	29.2
Output Power Factor	~1 (Adjustable from 0.8 leading to 0.8 lagging)		
Max. Total Harmonic Distortion	<3%		
AC Output Data (Back-up)			
Back-up Nominal apparent power (VA)	5000	6000	7000
Max. Output Apparent Power (VA)	6000	6000	7000
Peak Output Apparent Power (VA) ²	6000, 60sec	7200, 60sec	8400, 60sec
Max. Output Current (A)	20.8	25	29.2
Nominal Output Voltage (V)	120/240		
Nominal Output Frequency (Hz)	60		
Output THDv (@Linear Load)	<3%		

Technical Data	GEC5.0-1U-US10	GEC6.0-1U-US10	GEC7.0-1U-US10
Efficiency			
Max. Battery to Load Efficiency	96.6%		
Protection			
Anti-islanding Protection	Integrated		
DC Reverse Polarity Protection	Integrated		
AC Overcurrent Protection	Integrated		
AC Short Circuit Protection	Integrated		
AC Overvoltage Protection	Integrated		
AC Surge Arrester	Type III		
General Data			
Operating Temperature Range (°F)	-31°F~140°F (>113°F derating)		
Relative Humidity	0~95%		
Max. Operating Altitude (ft)	13124 ft (>9843 ft derating)		
Cooling Method	Smart Fan Cooling		
User Interface	WiFi + APP, LED		
Communication with BMS	RS485; CAN		
Communication with Meter	RS485		
Communication with Portal	Wi-Fi		
Weight (lb)	62.85	70.55	
Dimension W×H×D -in (in)	16.3in * 33.1in * 6.9in		
Noise Emission (dB)	<45		
Topology	Transformerless		
Night Power Consumption (W) ³	<20		
DC Connector	MC32*1.5		
AC Connector	MC32*1.5		
Protective class	Type 4X		
Environmental Category	4K4H		
Storage environments	-40°F~+185°F,0-95%RH,13124 ft		
Pollution Degree	III		
Overvoltage Category	PV II/AC IV		
The Decisive Voltage Class (DVC)	C(except for Communicaiton is A)		
Mounting method	Wall Bracket		
Type of electrical supply system	Split-phase Grid		
Certifications & Standards			
Grid Regulation	UL1741 SA, UL 1741 SB, California Rule 21, HECO Rule 14, IEEE 1547-2018, IEEE 1547a-2020, IEEE 1547.1-2020, HECO SRD V2.0		

Technical Data	GEC5.0-1U-US10	GEC6.0-1U-US10	GEC7.0-1U-US10
Safety Regulation	UL 1741, CSA C22.2 No. 107.1, UL 1998, UL991, UL1699B		
EMC	FCC part15 CLASS A&B		
<p>*1 Battery discharge/charge power limited by voltage</p> <p>*2 Can be reached only if battery power is enough</p> <p>*3 No Back-up Output</p>			

Technical Data	GEC7.6-1U-US10	GEC8.6-1U-US10	GEC9.6-1U-US10
Battery Input Data			
Battery Type	Li-Ion		
Nominal Battery Voltage (V)	300		
Battery Voltage Range (V) ¹	80~495		
Max Continuous Charging Current(A)	50		
Max Continuous Discharging Current (A)	50		
Max Charge Power (W)	7600	8600	9600
Max Discharge Power (W)	7600	8600	9600
AC Output Data (On-grid)			
Nominal Apparent Power Output to Utility Grid (VA)	7600	8600	9600
Max. Apparent Power Output to Utility Grid (VA)	7600	8600	9600
Nominal Apparent Power from Grid (VA)	7600	8600	9600
Max. Apparent Power from Utility Grid (VA)	9120	9600	9600
Nominal Output Voltage (V)	120/240		
Output Voltage Range (V)	211 to 264 @240		
Nominal AC Grid Frequency (Hz)	60		
AC Grid Frequency Range (Hz)	50-66Hz		
Max. AC Current Output to Utility Grid (A)	31.7	35.8	40
Max. AC Current From Utility Grid (A)	38	40	40
Nominal Output Current (A)	31.7	35.8	40
Output Power Factor	~1 (Adjustable from 0.8 leading to 0.8 lagging)		
Max. Total Harmonic Distortion	<3%		
AC Output Data (Back-up)			
Back-up Nominal apparent power (VA)	7600	8600	9600
Max. Output Apparent Power (VA)	7600	8600	9600
Peak Output Apparent Power (VA) ²	9120, 60sec	10320, 60sec	11520, 60sec
Max. Output Current (A)	31.7	35.8	40
Nominal Output Voltage (V)	120/240		
Nominal Output Frequency (Hz)	60		
Output THDv (@Linear Load)	<3%		

Technical Data	GEC7.6-1U-US10	GEC8.6-1U-US10	GEC9.6-1U-US10
Efficiency			
Max. Battery to Load Efficiency	96.6%		
Protection			
Anti-islanding Protection	Integrated		
DC Reverse Polarity Protection	Integrated		
AC Overcurrent Protection	Integrated		
AC Short Circuit Protection	Integrated		
AC Overvoltage Protection	Integrated		
AC Surge Arrester	Type III		
General Data			
Operating Temperature Range (°F)	-31°F~140°F (>113°F derating)		
Relative Humidity	0~95%		
Max. Operating Altitude (ft)	13124 ft (>9843 ft derating)		
Cooling Method	Smart Fan Cooling		
User Interface	WiFi + APP, LED		
Communication with BMS	RS485; CAN		
Communication with Meter	RS485		
Communication with Portal	Wi-Fi		
Weight (lb)	70.55		
Dimension W×H×D -in (in)	16.3in * 33.1in * 6.9in		
Noise Emission (dB)	<45		
Topology	Transformerless		
Night Power Consumption (W) ³	<20		
DC Connector	MC32*1.5		
AC Connector	MC32*1.5		
Protective class	Type 4X		
Environmental Category	4K4H		
Storage environments	-40°F~+185°F,0-95%RH,13124 ft		
Pollution Degree	III		
Overvoltage Category	PV II/AC IV		
The Decisive Voltage Class (DVC)	C(except for Communicaiton is A)		
Mounting method	Wall Bracket		
Type of electrical supply system	Split-phase Grid		
Certifications & Standards			
Grid Regulation	UL1741 SA, UL 1741 SB, California Rule 21, HECO Rule 14, IEEE 1547-2018, IEEE 1547a-2020, IEEE 1547.1-2020, HECO SRD V2.0		

Technical Data	GEC7.6-1U-US10	GEC8.6-1U-US10	GEC9.6-1U-US10
Safety Regulation	UL 1741, CSA C22.2 No. 107.1, UL 1998, UL991, UL1699B		
EMC	FCC part15 CLASS A&B		
*1 Battery discharge/charge power limited by voltage			
*2 Can be reached only if battery power is enough			
*3 No Back-up Output			

3.4.2 Auto-transformer Specification

Technical Data	
Rated Voltage (Vac)	120/240V Split Phase
Rated Frequency (Hz)	60
Max Continuous Output Current Per Phase @120V (A)	40
Split Phase Imbalance Current @ Rated Power (A)	40
Thermal Protection	YES
General Data	
Operating Temperature Range	-31°F~140°F (35°C~60°C)
Relative Humidity	0~95%
Operating Altitude (ft)	≤13123 ft (4000m)
Cooling Method	Natural Convection
Weight (lb)	48.5lb (22kg)
Dimension W×H×D	13.6in * 10.9in * 6.9in (345mm * 277mm * 174mm)
Mounting	Wall Bracket
Noise (dB)	<25
AC Conduit Size	1"
Protective Degree	NEMA Type 4X
Standard Warranty	10 Years
Certifications & Standards	
Safety Regulation	UL 1741

3.4.3 Grid Parameter Setting

For parameter, which used in grid support and protection function, adjustable requirement of CA Rule 21, HECO 14H and IEEE1547, the relevant explanations and setting methods can obtain by reading, <Parameter Adjustable Method Of Grid Support Utility Interactive Inverter>, the document can be obtained by contacting the after-sales.

Time frame	Steady-state measurements			Transient measurements		
	Parameter	Minimum measurement accuracy	Measurement window	Range	Minimum measurement accuracy	Measurement window
Voltage, RMS	($\pm 1\% V_{nom}$)	10 cycles	0.5 p.u. to 1.2 p.u.	($\pm 2\% V_{nom}$)	5 cycles	0.5 p.u. to 1.2 p.u.
Frequency ^b	10 mHz	60 cycles	50 Hz to 66 Hz	100 mHz	5 cycles	50 Hz to 66 Hz
Active Power	($\pm 5\% S_{rated}$)	10 cycles	0.2 p.u. < P < 1.0 p.u.	Not required	N/A	N/A
Reactive Power	($\pm 5\% S_{rated}$)	10 cycles	0.2 p.u. < Q < 1.0 p.u.	Not required	N/A	N/A
Time	1% of measured duration	N/A	5s to 600s	2 cycles	N/A	100 ms < 5 s

a Measurement accuracy requirements specified in this table are applicable for voltage THD < 2.5% and individual voltage harmonics < 1.5%.

b Accuracy requirements for frequency are applicable only when the fundamental voltage is greater than 30% of the nominal voltage.

3.5 Maintenance



WARNING!

These servicing instructions are for use by qualified personnel only. To reduce the risk of electric shock, do not perform any servicing other than that specified in the operating instructions.

Ces instructions d'entretien sont destinées uniquement au personnel qualifié. Pour réduire le risque de choc électrique, n'effectuez aucun service autre que celui spécifié dans les instructions d'exploitation.

3.5.1 Clearing and Replacing Fans

GEC inverter is equipped with two or three fans on its back side. The fans should be cleared yearly. Before clearing or replacing the fans, turn off all switches including battery switch and AC breaker switch.

Step 1

Separate the plug terminal by pressing the buckle.



Step 2

Clean the ventilation grid and the fan with soft brush, paint brush, or compressed air. Reassemble the fans into the cabinet.

If there is something wrong with the fan and need to be repaired or replaced, disassemble the fans following the above steps.

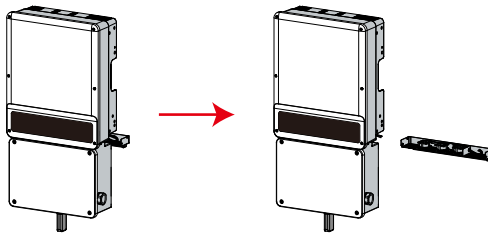

3.5.2 Fuse Replacement

If the inverter fuses are broken, replace them quickly. Before the replacement, all the power (PV, battery, AC) connected by GEC must be turned off. Otherwise it will bring danger. The fuse must be of the same size, the current specification must be the same as the original fuse or higher, not less than the original specification. Steps are as follows:

Step 1

Remove the 4 screws by Allen Wrench.
Remove the cover.

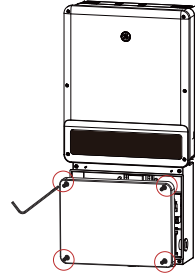

Step 2

Remove 5 screws by cross screwdriver.
Remove the black plastic board.
Confirm that the fuses are broken.

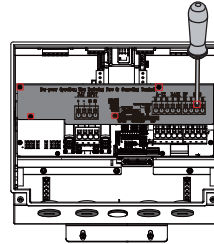

Step 3

Remove the broken fuses in the middle on vertical direction which is shown in the left figure and don't remove fuses by prying or other methods.
Replace the fuses on vertical direction.

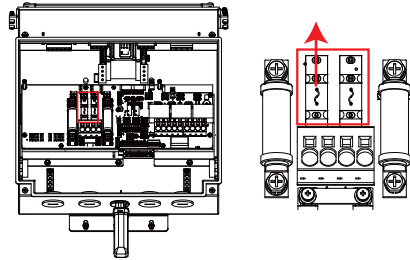

Step 4

Remove 4 screws .
Remove the broken fuses which is shown in the right figure and replace them.
Fasten the screws.

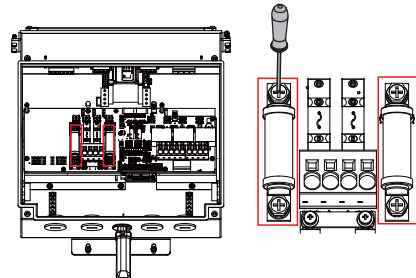

3.5.3 About Periodical Maintenance

The AC-COUPLED Inverter requires little to no maintenance, at a minimum, conduct a visual inspection: Check the enclosure for any signs of wear and tear. Lookout for ingress of water or pests. Any issues described above shall only be addressed by a trained certified personnel, otherwise the warranty will be invalid.

Appendix

Other Tests

For Australian requirements, in the THDi test, Zref should be added between the inverter and mains.

RA, XA for the line conductor

RN, XN for the neutral conductor

Zref:

RA = 0, 24, XA = j0,15 at 50Hz

RN = 0, 16, XN = j0,10 at 50Hz

Moisture Parameters	Level		
	3K3	4K3	4K4H
Temperature Range	0~+40°C	-33~+40°C	~20~+55°C
Moisture Parameters	5%~85%	15%~100%	4%~100%

Environment category definition

Environment Condition	Ambient Temperature	Relative Humidity	Applied to
Outdoor	-20~50°C	4%~100%	PD3
Indoor Unconditioned	-20~50°C	5%~95%	PD3
Indoor conditioned	0~40°C	5%~85%	PD2

Overvoltage category definition

Category I	Applies to equipment connected to a circuit where measures have been taken to reduce transient overvoltage to a low level.
Category II	Applies to equipment not permanently connected to the installation. Examples are appliances, portables tools and other plug-connected equipment.
Category III	Applies to a fixed equipment downstream, including the main distribution board. Examples are switchgear and other equipment in an industrial installation.
Category IV	Applies to equipment permanently connected at the origin of an installation (upstream of the main distribution board). Examples are electricity meters, primary over-current protection equipment and other equipment connected directly to outdoor open lines.

Pollution degree definition

Pollution Degree I	No pollution or only dry, non-conductive pollution occurs. The pollution has no influence.
Pollution Degree II	Normally only non-conductive pollution occurs. Occasionally, however, a temporary conductivity caused by condensation must be expected.
Pollution Degree III	Conductive pollution occurs, or dry, non-conductive pollution occurs, which becomes conductive due to condensation, which is expected.
Pollution Degree IV	Persistent conductive pollution occurs, for example, the pollution caused by conductive dust, rain or snow.





**Intelligence
Switched On**

Global Sales & Service Network

* GE is a registered trademark of General Electric Company and is used under license by GoodWe Technologies Co.,Ltd.
© 2022 All Rights Reserved

 www.gesolarinverter.com

 sales@gesolarinverter.com; support1@gesolarinverter.com



Local Contacts